

McStas Introduction



Peter Willendrup^{1,5}

Emmanuel Farhi²

Erik Knudsen^{1,5}

Emmanouela Rantsiou³

Christine Klauser³

Kim Lefmann^{4,5}

¹DTU Physics, Lyngby, Denmark

²Calcul Scientifique, Institut Laue-Langevin (ILL), Grenoble, France

³Niels Bohr Institute, University of Copenhagen, Copenhagen, Denmark

⁴Paul Scherrer Institut, Villigen, Switzerland

⁵ESS DMSC, Copenhagen, Denmark

McStas

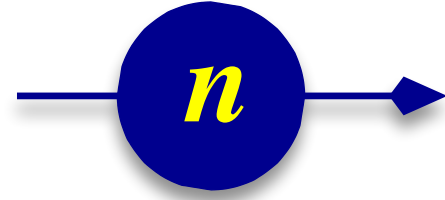

Agenda



- | A (very) brief introduction to neutrons, Monte Carlo & raytracing
- | Components of neutron instruments
- | How McStas works under the hood
- | Components and instruments
- | A demo



McStas: Neutrons, Monte Carlo & ray-tracing

Neutron

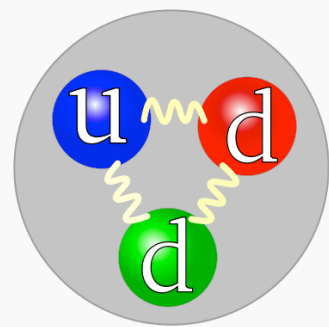

The quark structure of the neutron. (The color assignment of individual quarks is not important; what is important is that all three colors are present.)

Classification	Baryon
Composition	1 up quark, 2 down quarks
Statistics	Fermionic
Interactions	Gravity, Weak, Strong, Electromagnetic
Symbol	n^0 , N^0
Antiparticle	Antineutron
Theorized	Ernest Rutherford ^{[1][2]} (1920)
Discovered	James Chadwick ^[1] (1932)
Mass	1.674 927 351 (74) $\times 10^{-27}$ kg ^[3] 939.565 378 (21) MeV/c ² ^[3] 1.008 664 916 00 (43) u ^[3]
Mean lifetime	881.5 (15) s (free)
Electric charge	0 e 0 C
Electric dipole moment	$< 2.9 \times 10^{-26}$ e-cm
Electric polarizability	$1.16(15) \times 10^{-3}$ fm ³



Subatomic particle discovered by Sir James Chadwick, 1932



Nobel Prize in Physics, 1994



Awarded for “pioneering contributions to the development of neutron scattering techniques for studies of condensed matter”

Bertram N. Brockhouse

Clifford G. Shull

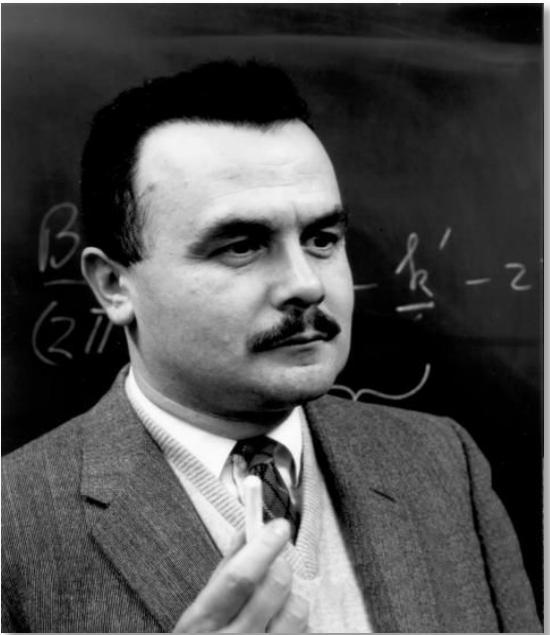

Neutron spectroscopy

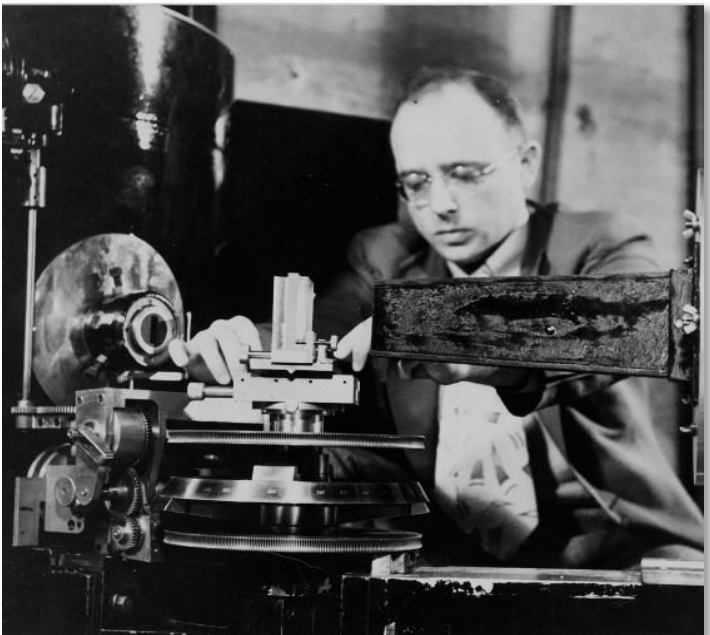

Neutron diffraction technique



1994 Nobel prize to Shull & Brockhouse

Neutrons show where the atoms are....

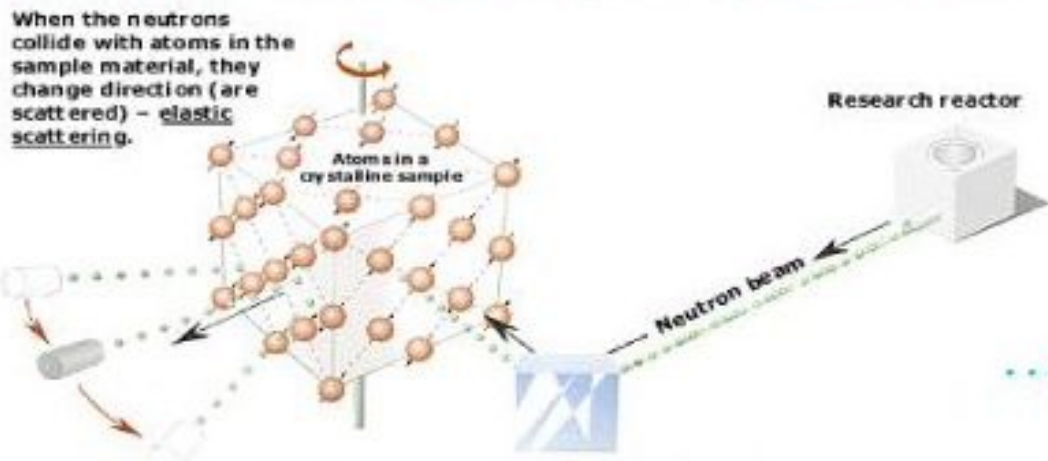

...and what the atoms do.

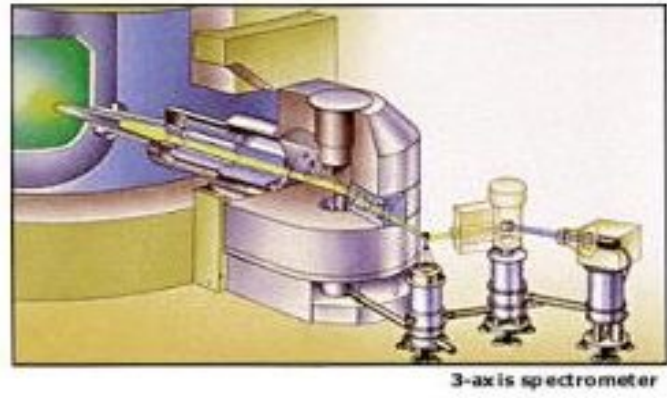
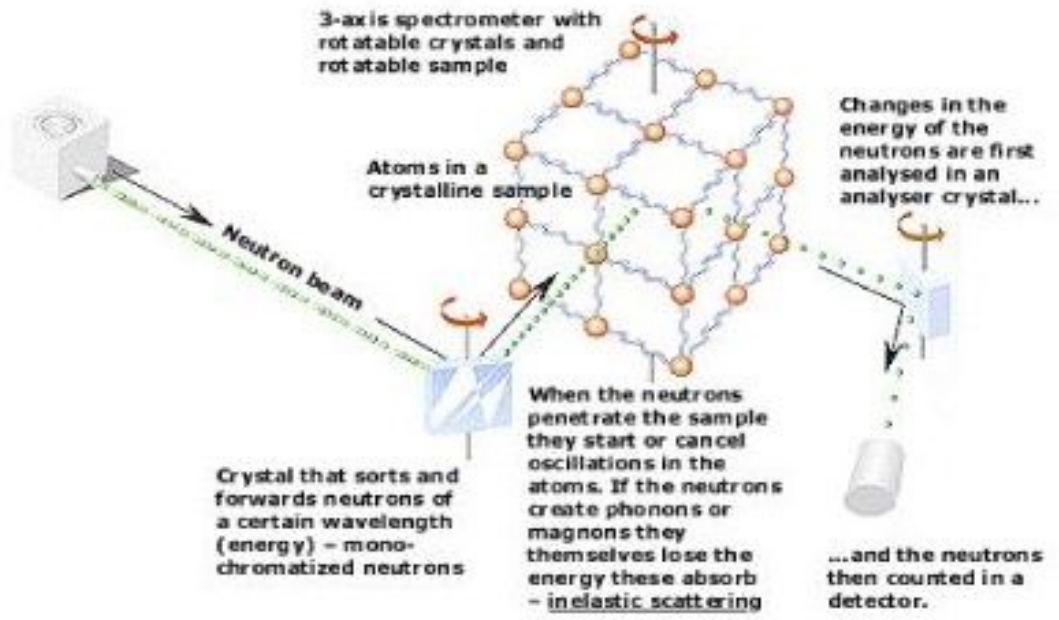

Neutron facilities

Fission

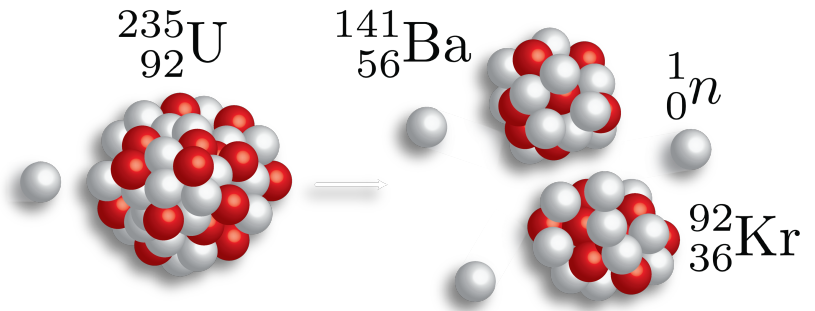

Spallation

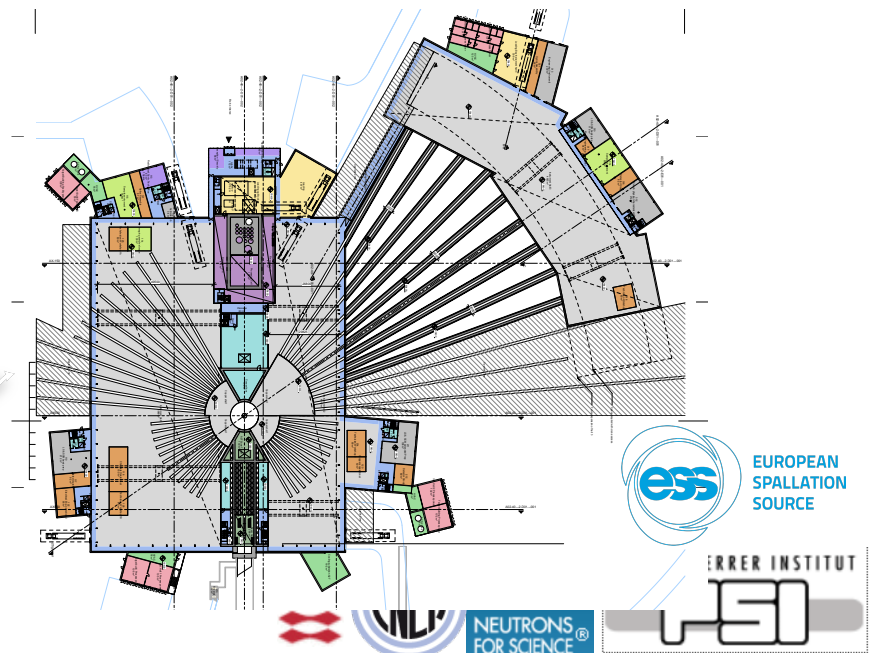
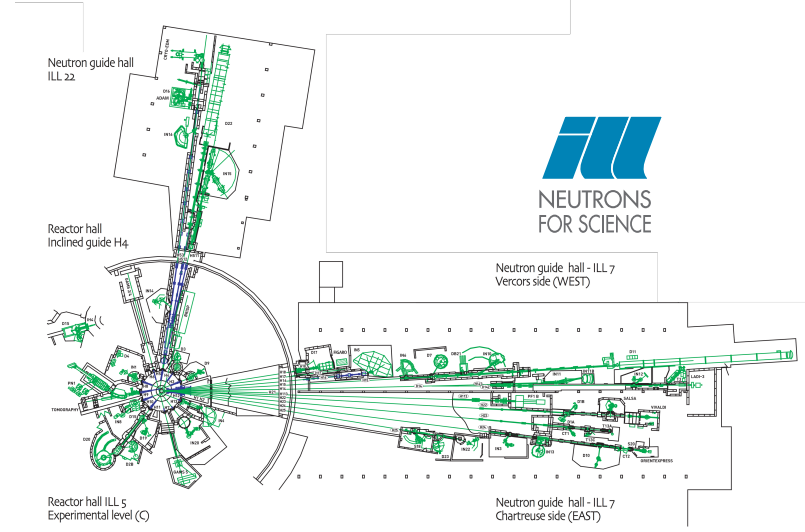
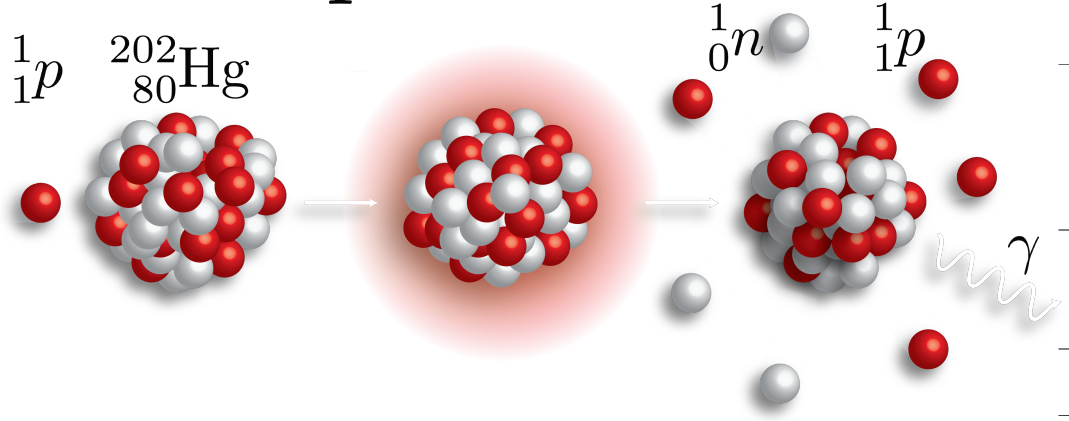

Origin of Monte Carlo methods

Used by Nature since ... (a long time) : diversity of Life



First application using computers:

Metropolis, Ulam and Von Neumann at Los Alamos, 1943

Neutron Scattering and Absorption in *U* and *Pu*, Origin of MCNP

Name:

Monte Carlo casino, a random generator (Ulam's father played poker)



What are Monte Carlo methods ?

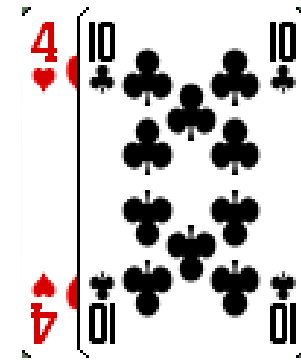

- Use random generators (play poker)
- Explore a complex and large phase space (many parameters)
- Integrates microscopic random events into measurable quantities **not** a usual regular sampling integration

$$\lim_{n \rightarrow \infty} \frac{1}{n} \sum_{i=1, a < u_i < b}^n f(u_i) = \frac{1}{b-a} \int_a^b f(u) du$$

- Metropolis* algorithm: model energy gap E as a probability

$$p \propto e^{-E/kT}$$

- Integrals converge faster than any other method (for $d > 3$) when using *enough* independent events (central limit theorem)
- F. James, *Rep. Prog. Phys.*, Vol. **43** (1980) 1145.



Good random generator:

from thermal electronic noise (hardware)

or quasi-random generators \Rightarrow *quasi*-Monte-Carlo

We encounter a probability $0 < p < 1$.

Crude Monte-Carlo (yes/no choice):

We shoot n events $\xi \in [0,1]$

We keep events that satisfy $\xi < p$

np events \rightarrow low statistics

Importance sampling (fuzzy choice – event weighting):

Keep n events, no more random number...

But associate a **weight** p to each of them (we set $\xi = p$)

Retain statistical accuracy ($1/\div n$)

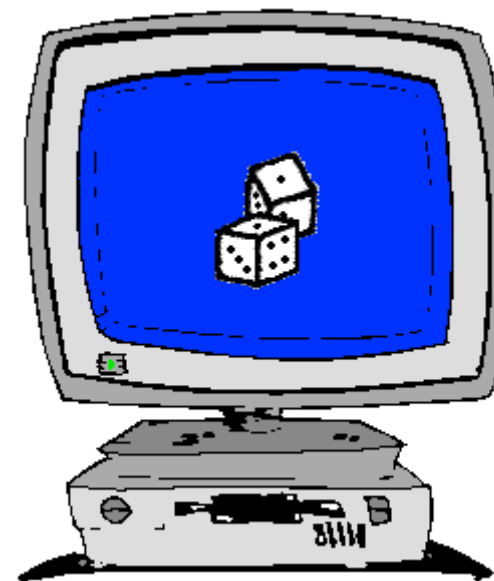

When to use Monte Carlo methods

Dimensionality of phase space must be large ($d > 5$)

Overall complexity is beyond reasonable analytical methods

Each event can be computed easily and independently MC is the '*lazy guy*' method – think microscopic

- Estimate π from a circle/square (“*Buffon needle*”)
- Area under/inside a curve/volume (integration)
- Molecular Dynamics
- spin-system phase transitions (*Ising* model)
- nuclear reactions
- ray-tracing (light, particles)

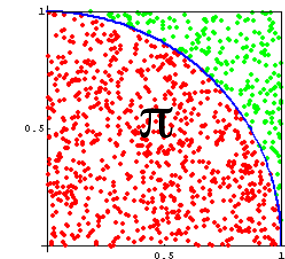
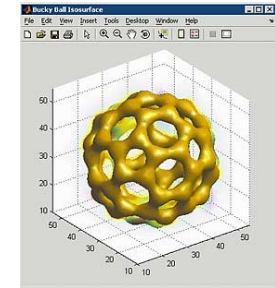

Number of points for which
 $\{ x^2+y^2 \leq 1, (x,y) \in [0,1] \}$
Ratio circle/square $\rightarrow \pi/4$



Examples of Monte Carlo programs



Each time physics takes place (scattering, absorption, ...) random choices are made.

Light ray-tracing: PoV-RAY and others ...

Nuclear reactor simulations (neutron transport):

MCNP, Tripoli, GEANT4, FLUKA

Neutron Ray-Tracing propagation:

McStas <www.mcstas.org>, Vitess, Restrax, NISP, IDEAS

Neutrons are described as $(\mathbf{r}, \mathbf{v}, \mathbf{s}, \mathbf{t})$, and are transported along models.

Propagation simply uses Newton rules, incl. gravitation.

X-ray tracing

Shadow, McXtrace



Monte Carlo techniques

- Los Alamos has since then developed and perfected many different monte carlo codes leading to what is today known as the codes MCNP5 and MCNPX
- State of the art is MCNPX (or soon the merged MCNP6 code) that features numerous (even exotic) particles
- MCNP was originally Monte Carlo Neutron Photon, later N-Particle
- Mainly used for high-energy particle descriptions in weapons, power reactors and routinely used for estimating dose rates and needed shielding
- Does not to date handle coherent scattering of neutrons due to the focus on high energies

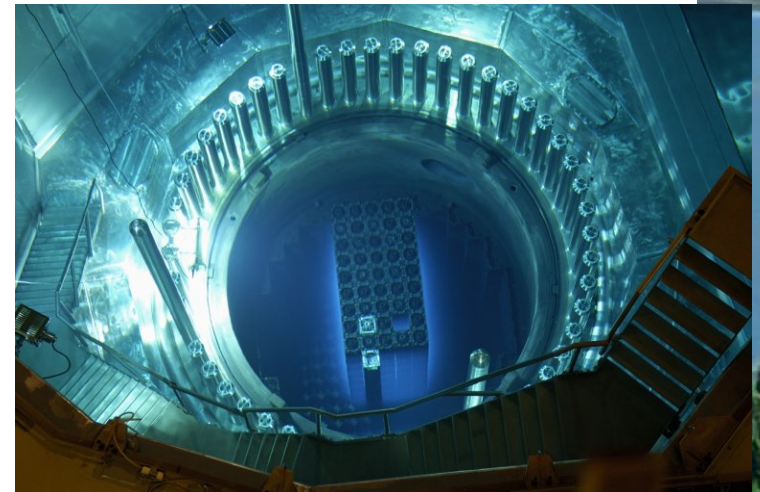
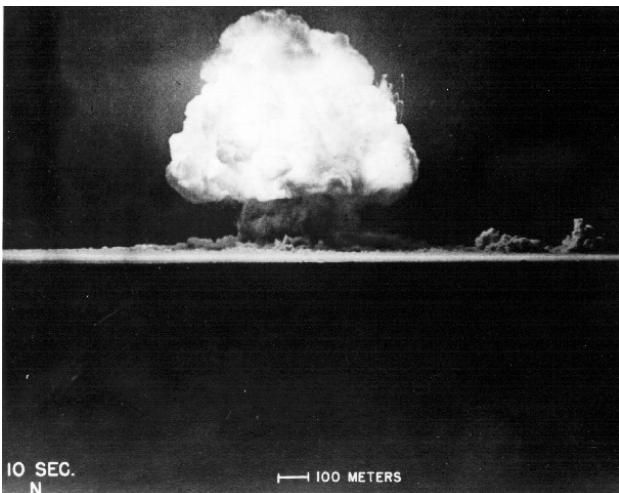

Ray-tracing methods

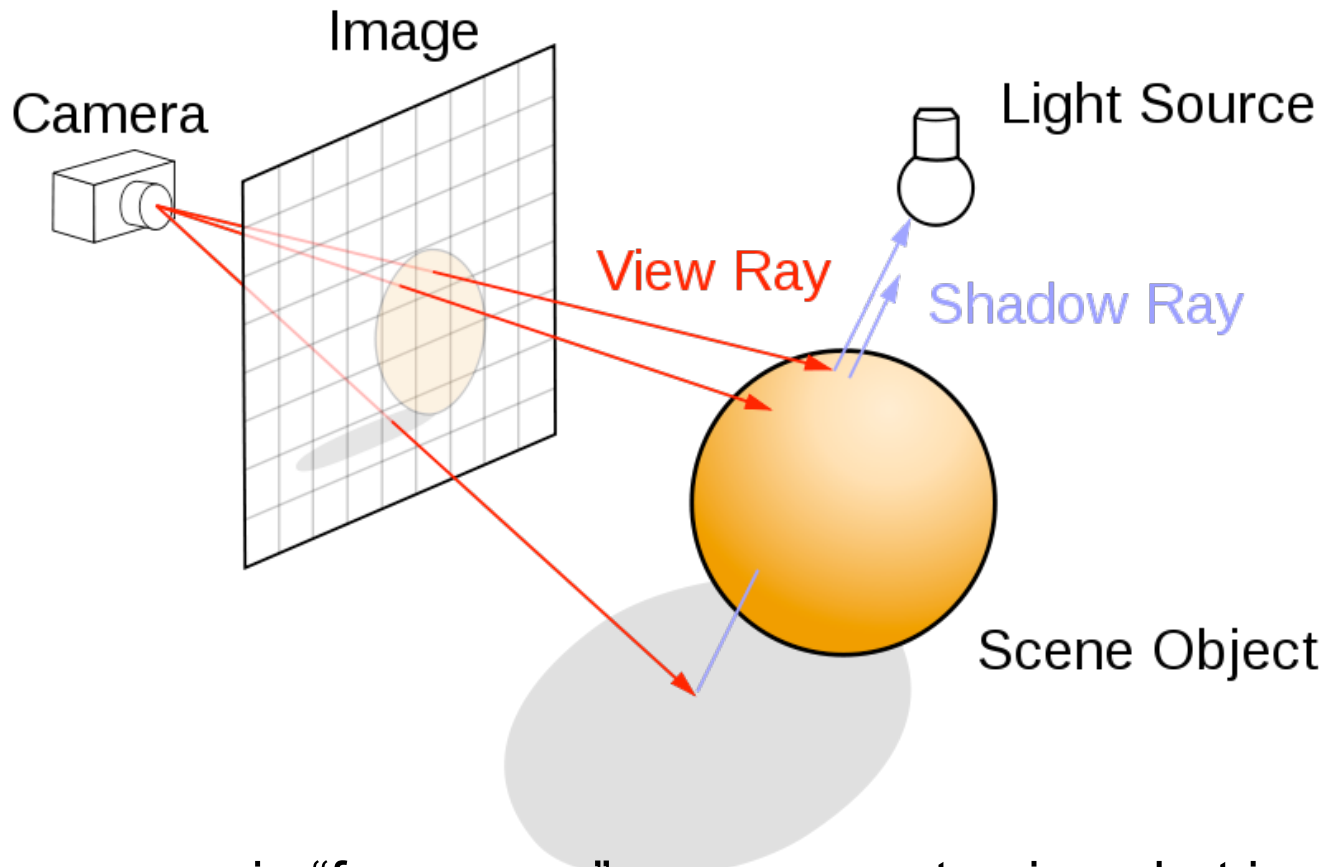

- When neutrons move in “free space”, we use ray-tracing - but in most cases in direction source -> detector
- Of course parabolas rather than straight lines are used to implement gravity



- | Instrument Monte Carlo methods implement coherent scattering effects
- | Uses deterministic propagation where this can be done
- | Uses Monte Carlo sampling of “complicated” distributions and stochastic processes and multiple outcomes with known probabilities are involved
- | - I.e. inside scattering matter
- | Uses the particle-wave duality of the neutron to switch back and forward between deterministic ray tracing and Monte Carlo approach

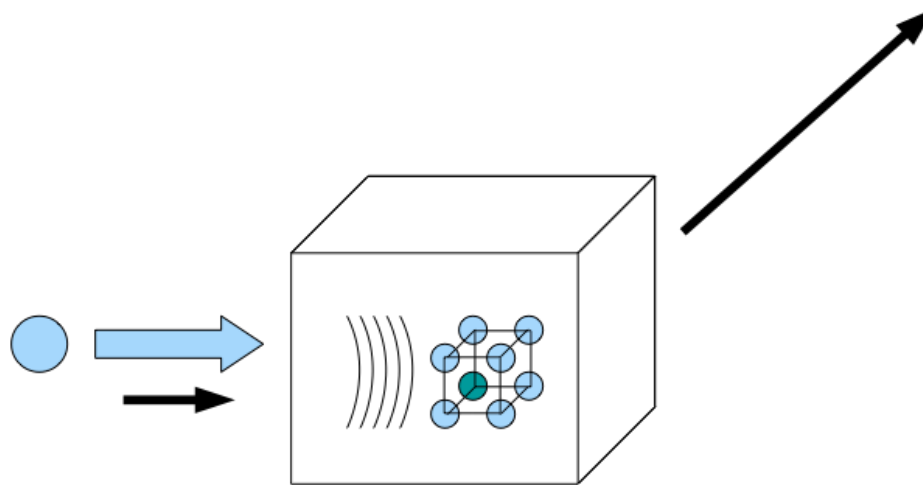

- | Result: A realistic and efficient transport of neutrons in the thermal and cold range



Components of neutron instruments

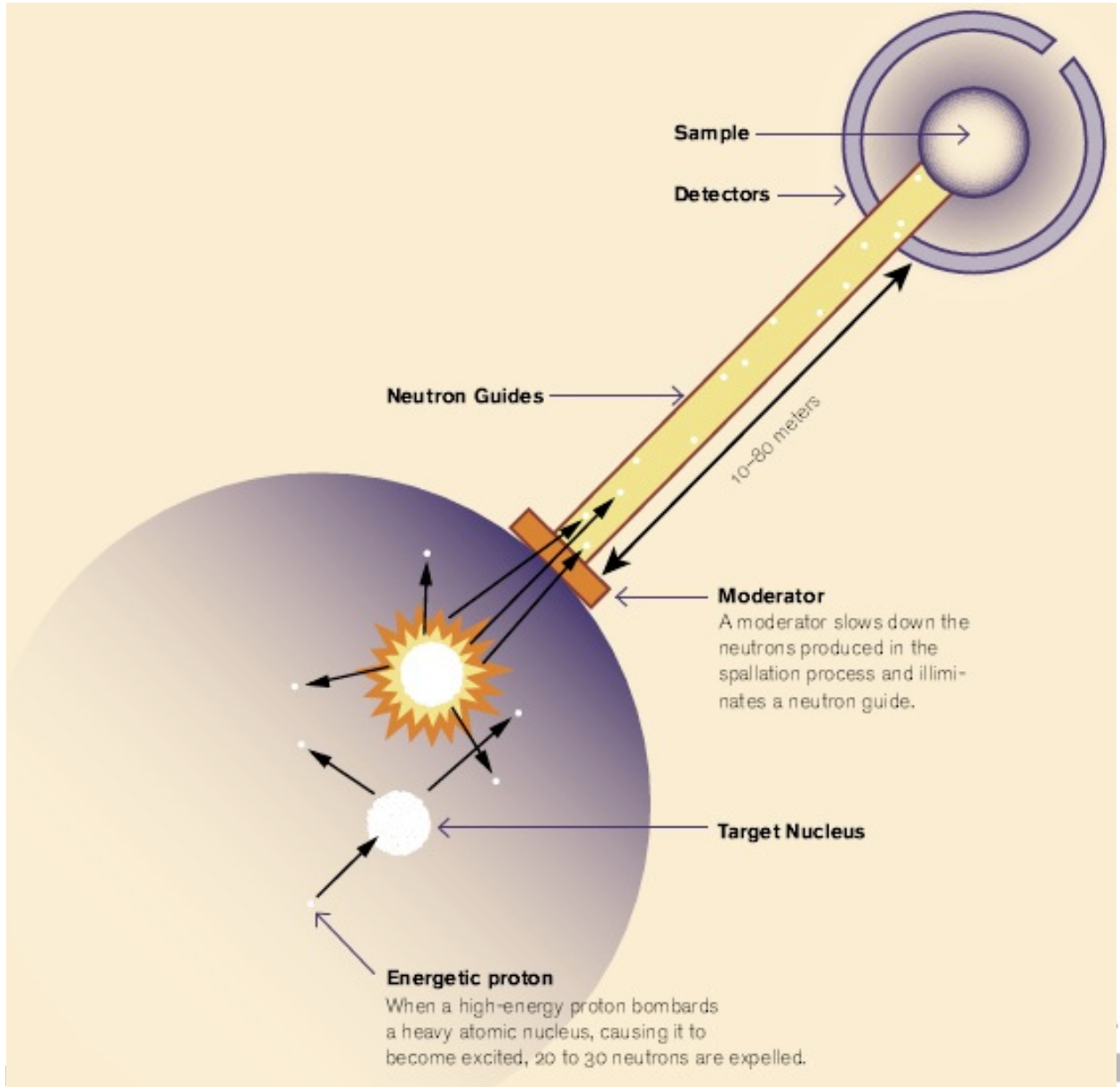

Moderators... (Where McStas starts)

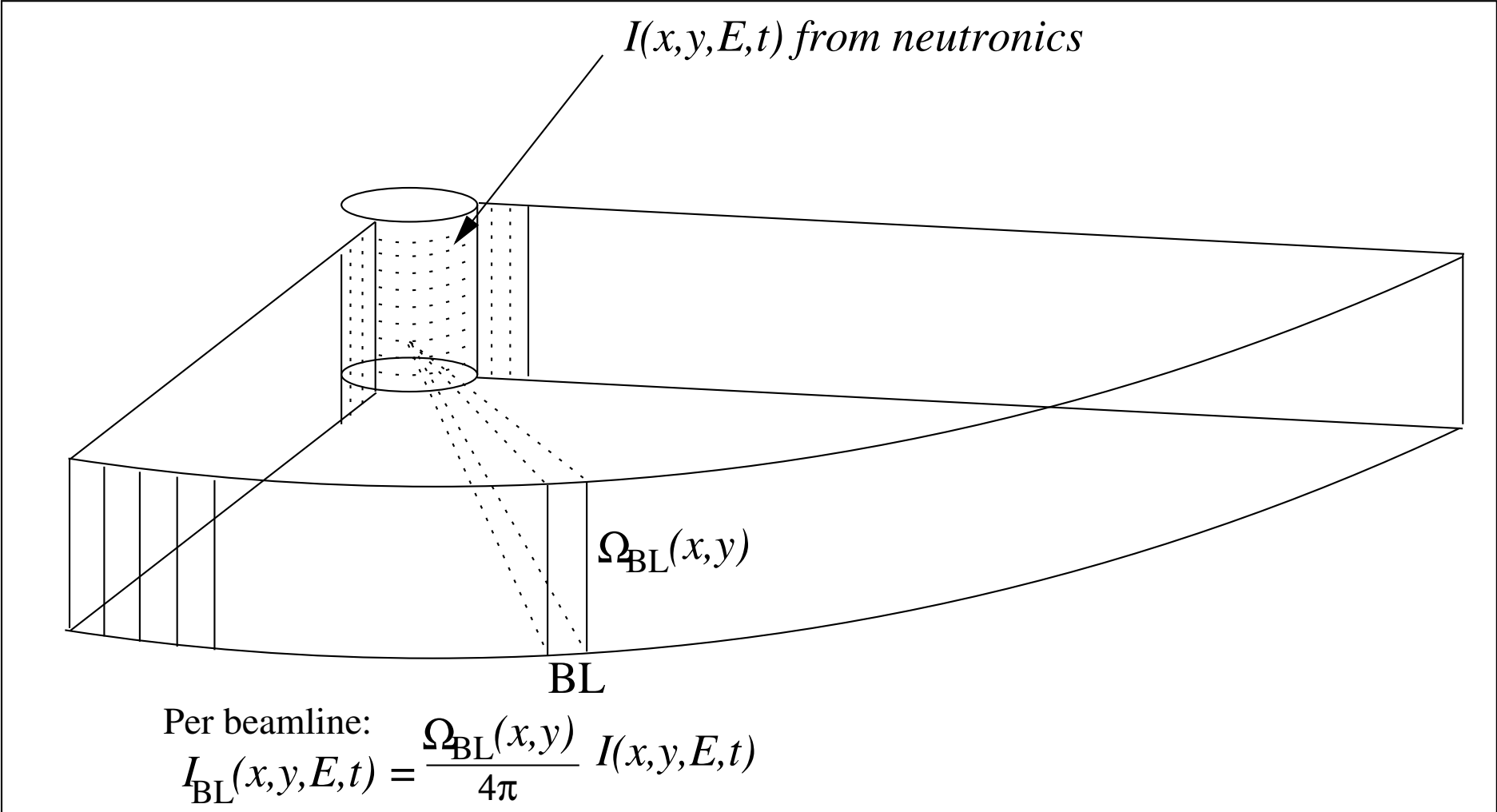

Neutron guides



Collimators & slits

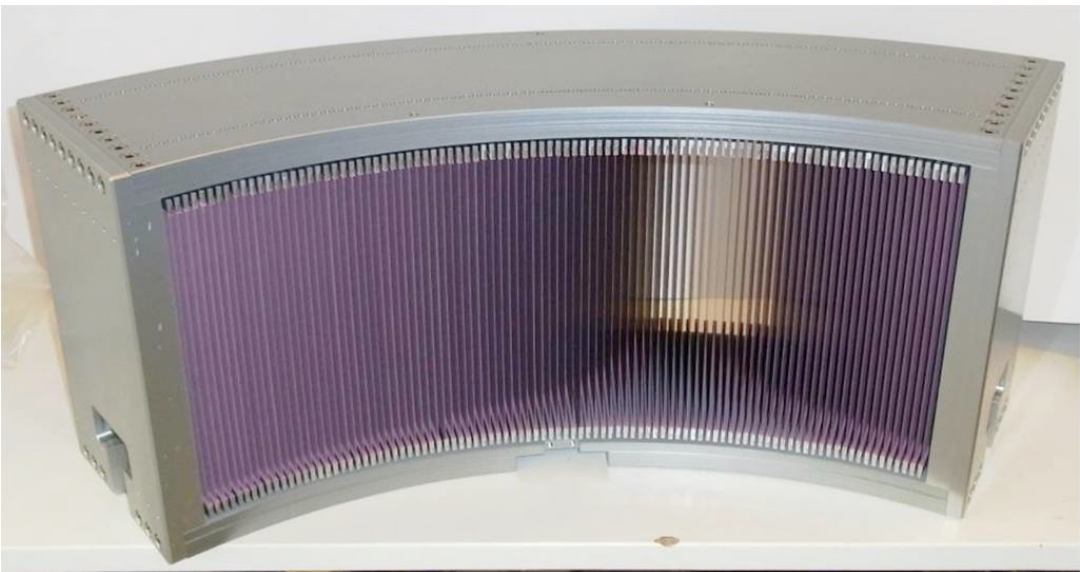

Disk Choppers

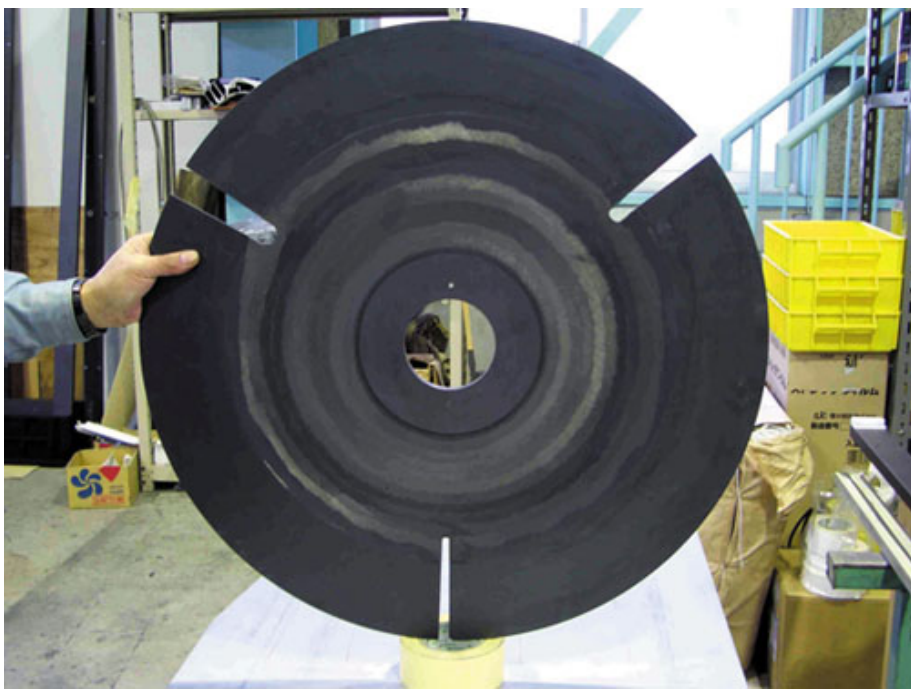
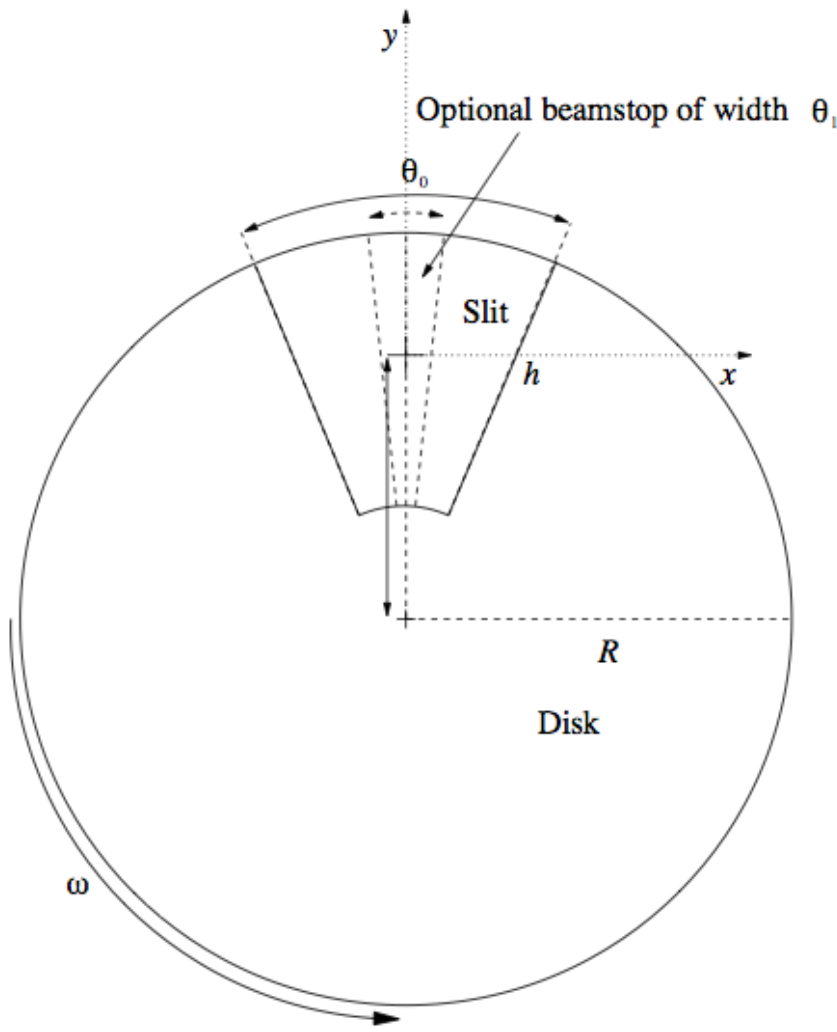

Velocity selector

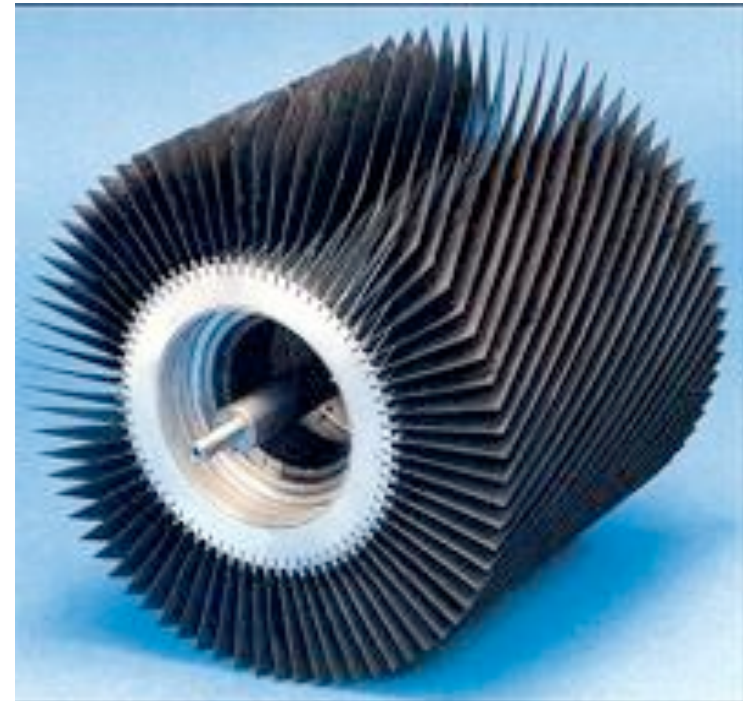

Fermi Choppers

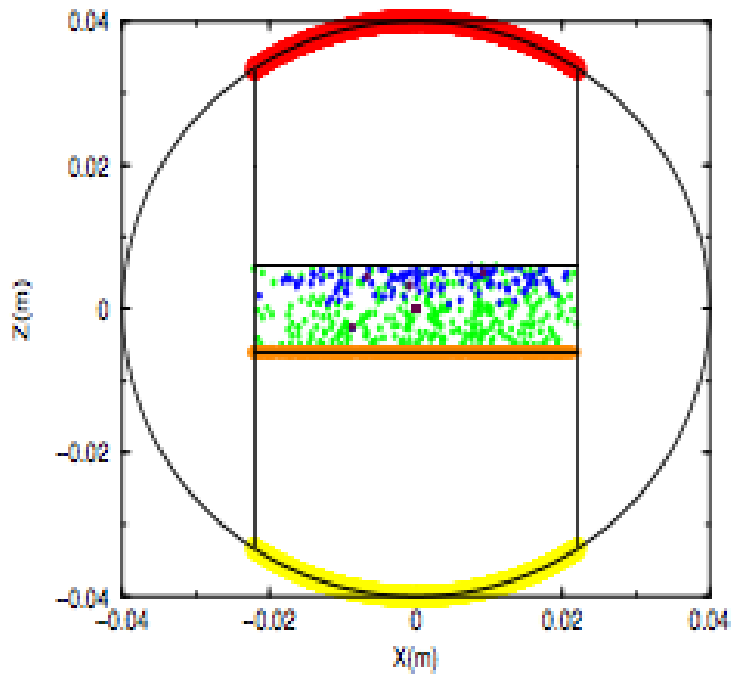
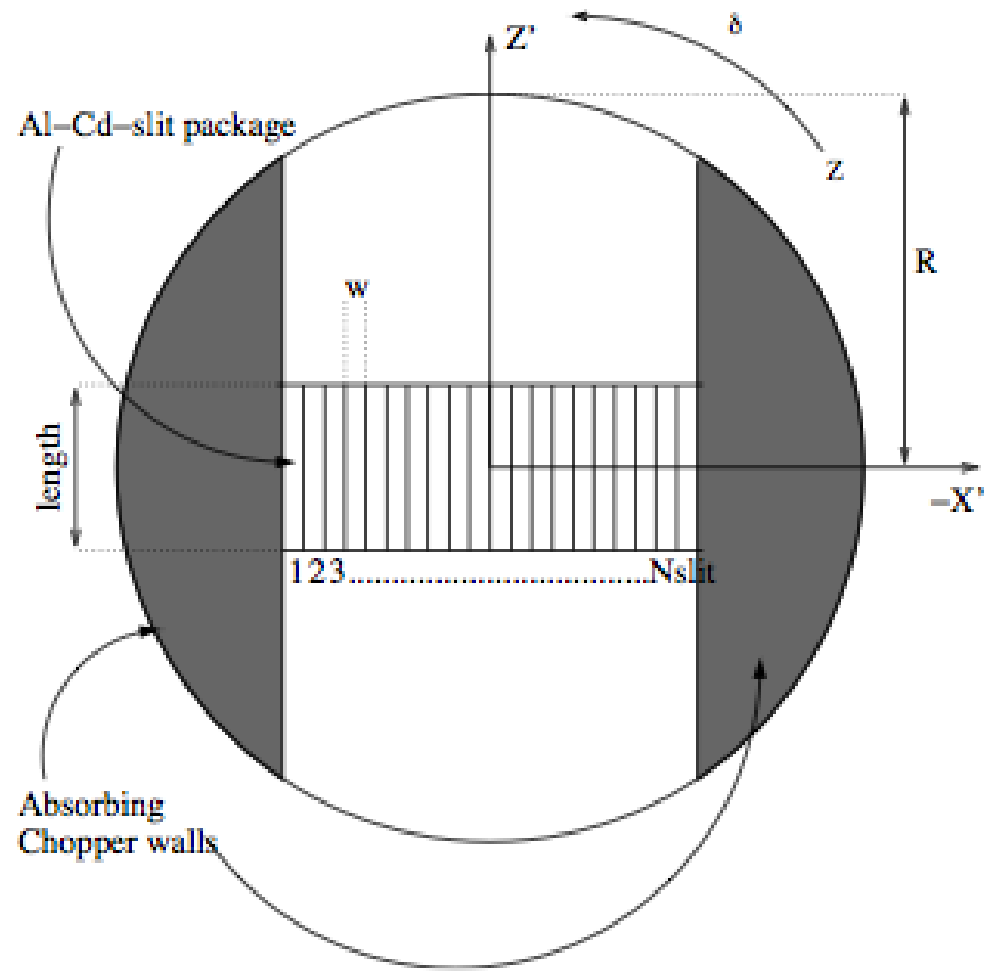

Crystal monochromators (and analyzers)

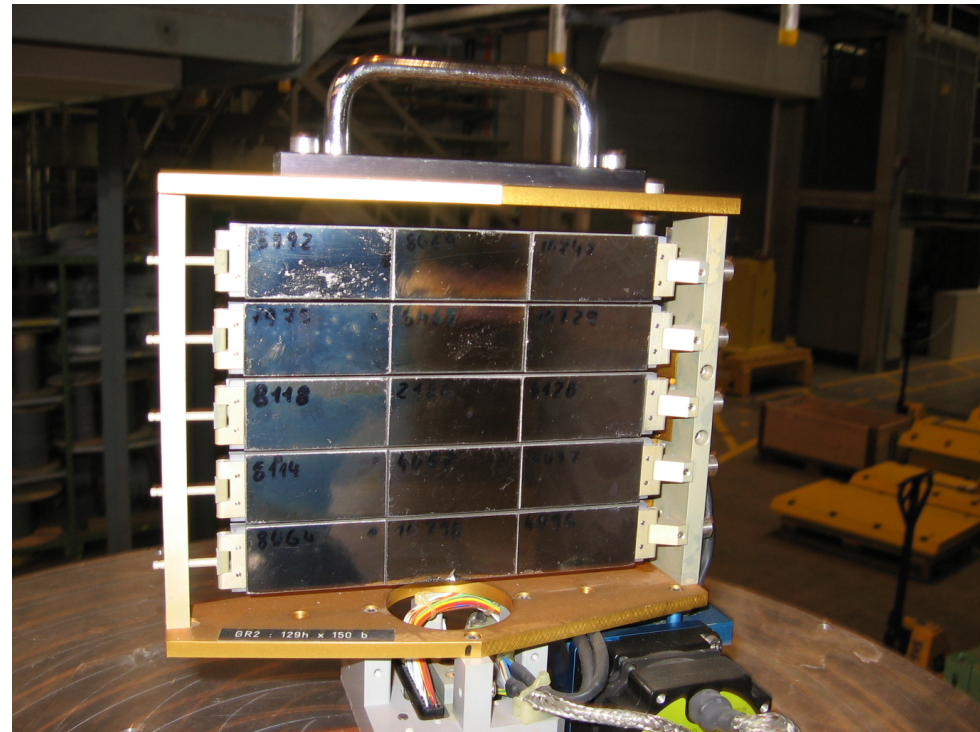

Samples studied...

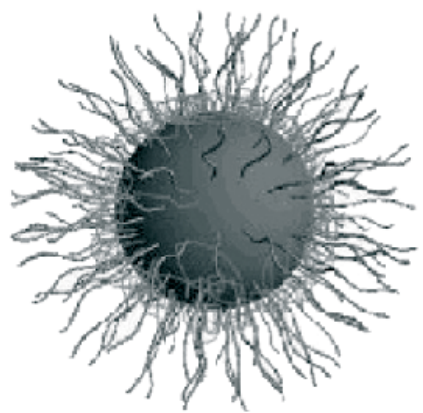
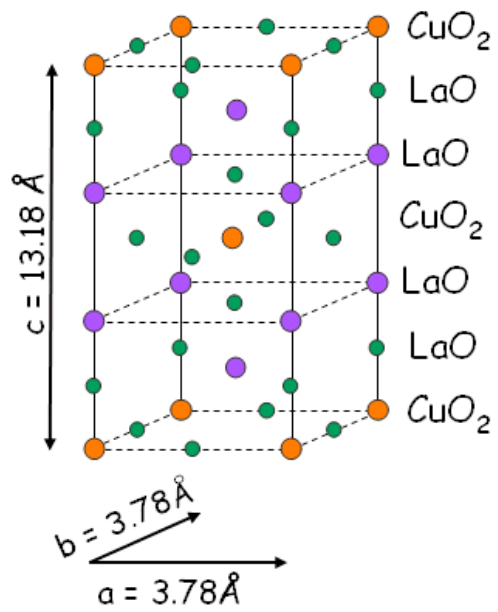

Detectors

X

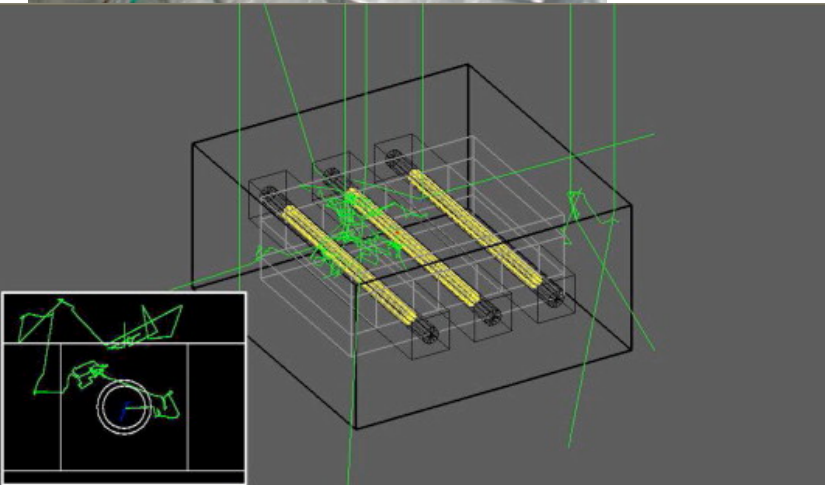

McStas Introduction



- Flexible, general simulation utility for neutron scattering experiments.
- Original design for Monte carlo Simulation of triple axis spectrometers
- Developed at DTU Physics, ILL, PSI, Uni CPH, ESS DMSC
- V. 1.0 by K Nielsen & K Lefmann (1998) RISØ
- Currently 2.5+1 people full time plus students



GNU GPL
license
Open Source

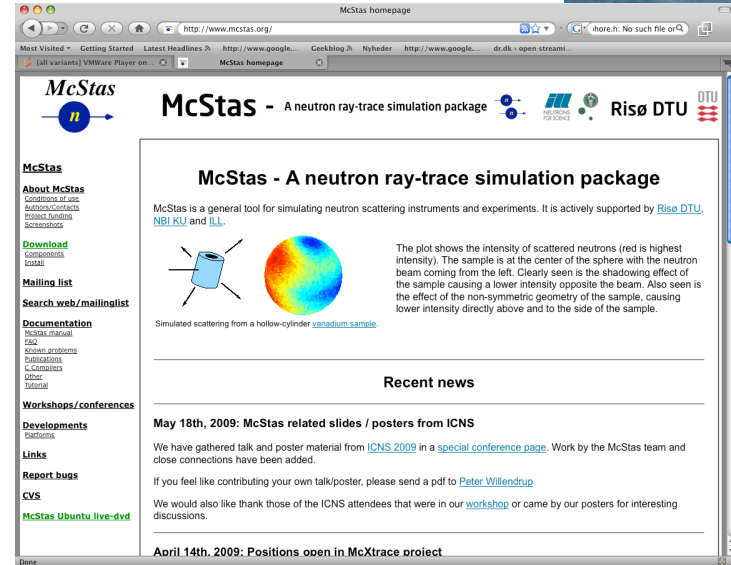

Project website at
<http://www.mcstas.org>

mcstas-users@mcstas.org mailinglist



McXtrace - since jan 2009 similar for X-rays

The screenshot shows a web browser window titled "Main Page - McXtraceWiki". The address bar contains the URL "http://www.mcxtrace.org/index.php?title=Main_Page". The page content includes the McXtrace logo, a navigation menu, a search box, and a toolbox. The main text describes McXtrace as a joint venture by Risø DTU, DTU, ESRF, and JJ X-RAY. It also mentions funding from NABIIT, DSF, and the above parties, and states that the code will be based on technology from McStas. A mailing list subscription link is provided.

navigation

- Main Page
- Partners
- Project People
- Project Status
- Vacancies
- Project Goal
- Mailing List
- Links
- SMEXOS talks
- SRI09 abstracts

search

Go Search

toolbox

- What links here
- Related changes
- Upload file
- Special pages
- Printable version
- Permanent link

Main Page

McXtrace

McXtrace - Monte Carlo Xray ray-tracing is a joint venture by

Risø DTU DTU ESRF JJ X-RAY

Funding from NABIIT, DSF and the above parties.

Our code will be based on technology from McStas

For information on our progress, please subscribe to our user mailinglist.

mailto:webmaster@mcxtrace.org

This page was last modified 13:15, 25 February 2009. This page has been accessed 2,049 times. Privacy policy About McXtraceWiki Disclaimers

Powered By MediaWiki

- Synergy, knowledge transfer, shared infrastructure

McStas Introduction

A world map with red and blue regions. Various neutron source logos are placed on the map: SNS (USA), Argonne (USA), NIST (USA), ISIS (UK), PSI (Switzerland), ESS (Europe), CARR (USA), CSNS (China), and Ansto (Australia). The text "World leading in neutron Monte Carlo" is written across the bottom of the map area.

What is McStas used for?

- Instrumentation
- Virtual experiments
- Data analysis
- Teaching

(KU, DTU)

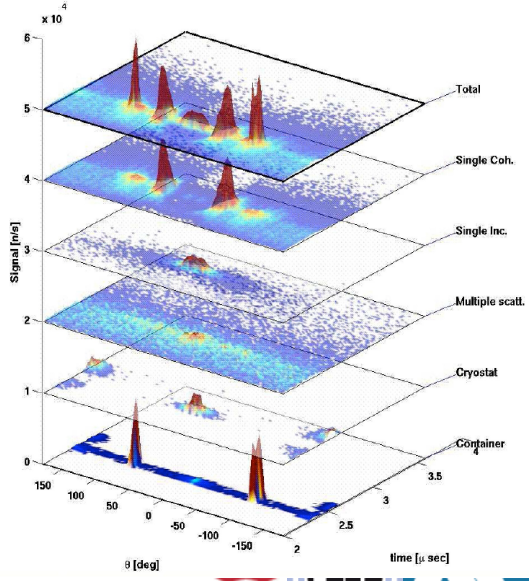
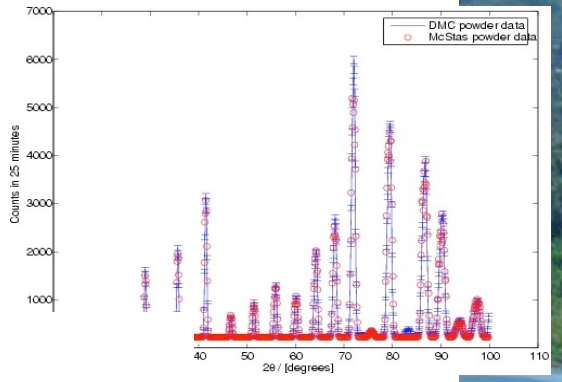
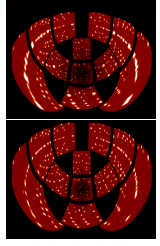
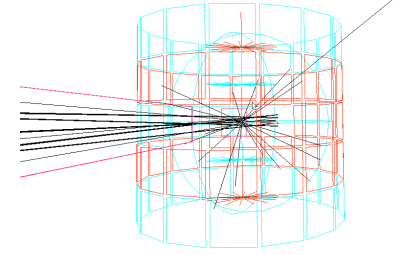
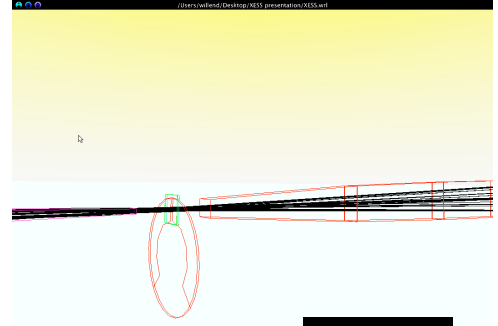
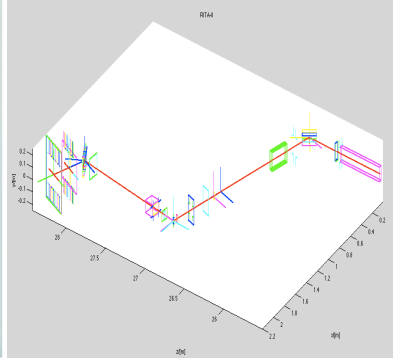
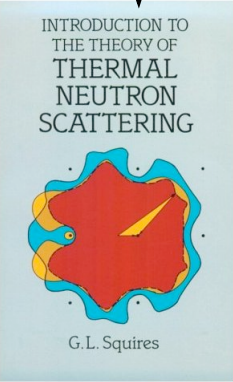

Instrumentation

- Design and optimization of instruments

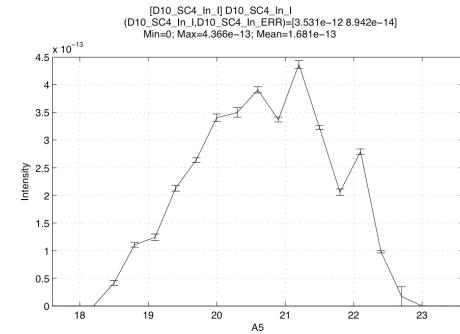
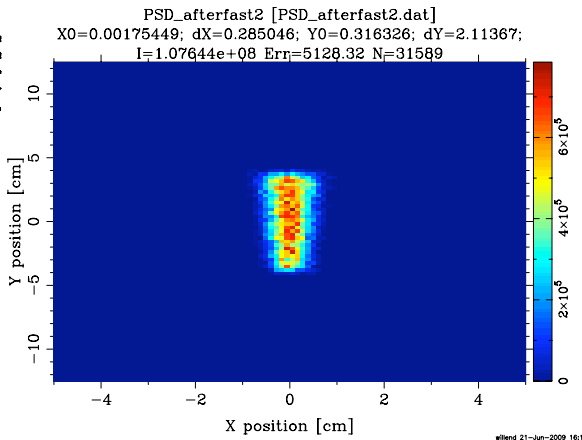
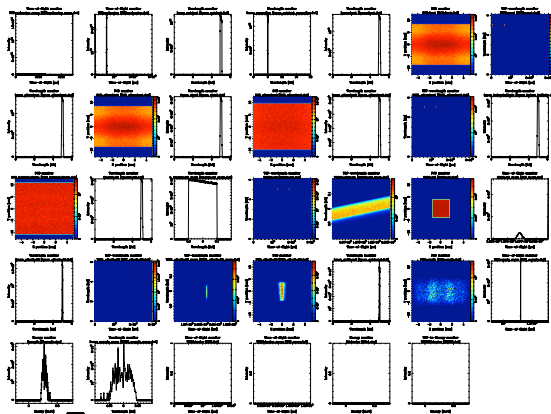
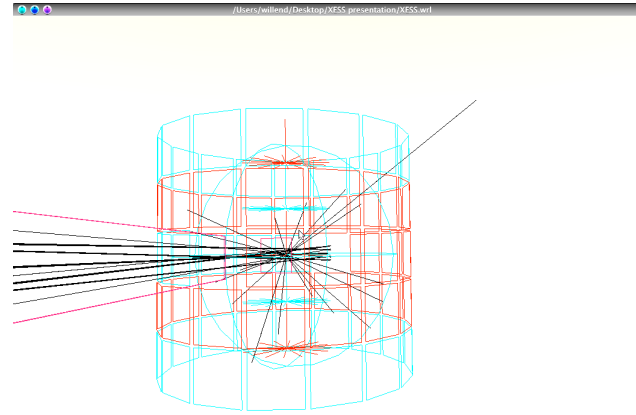
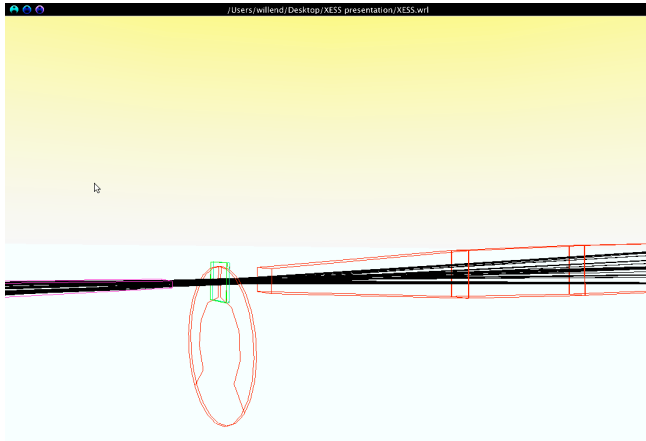

Virtual experiments (VE)

(definition:)

- Simulation of a complete experiment
- ... from source to detector
- Ideally controlled like real experiment.
- Data analysed by "real" analysis programs

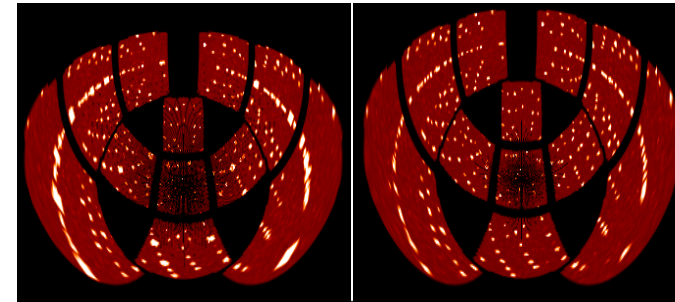

A. Daud-Aladine, ISIS

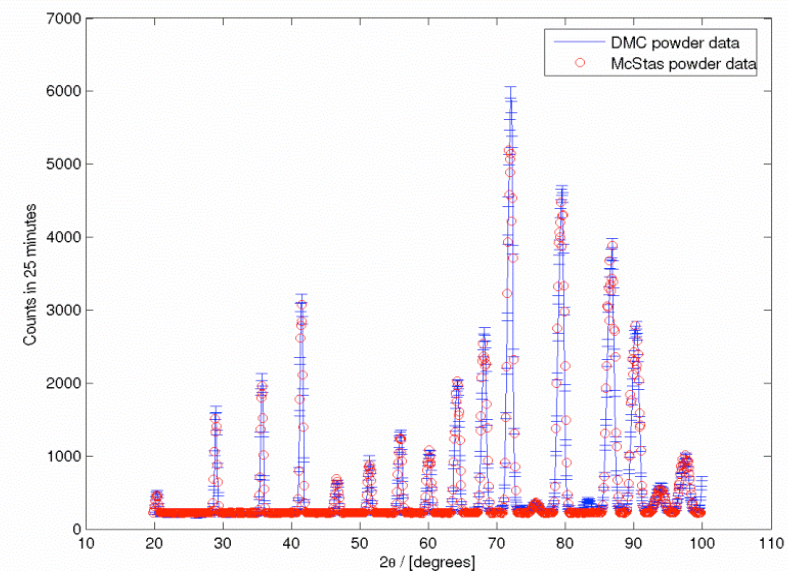
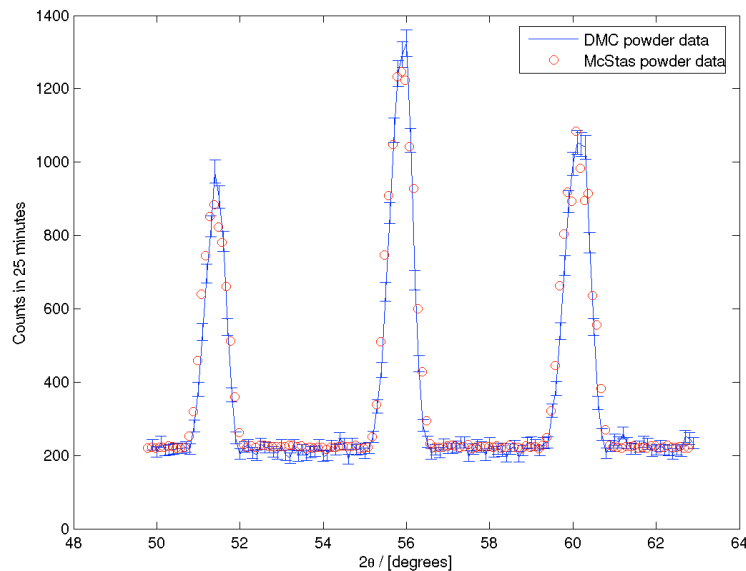

P. Willendrup, Risø DTU; Uwe Filges, L. Keller, PSI



Data analysis (1)

(using VE techniques)

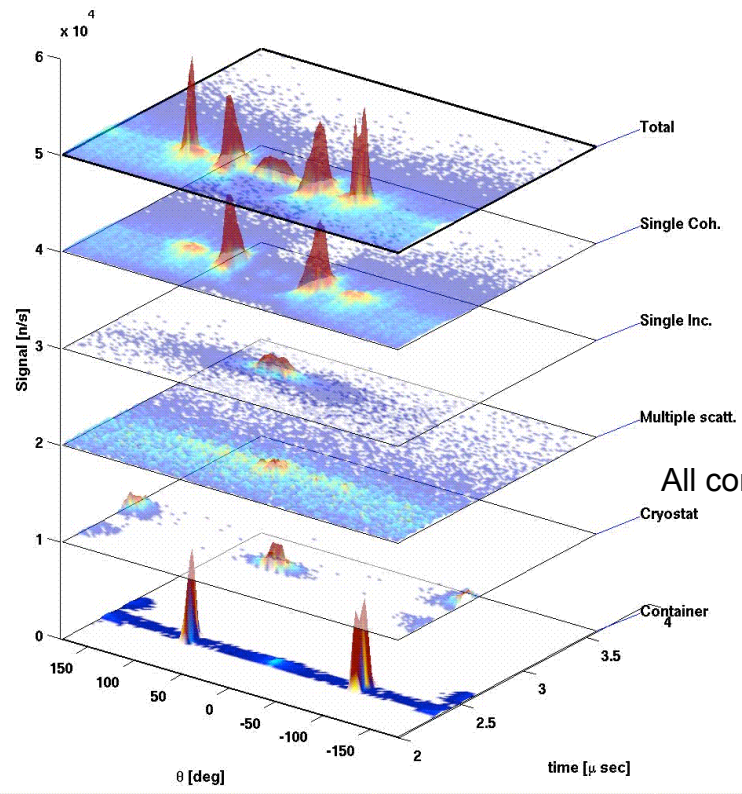
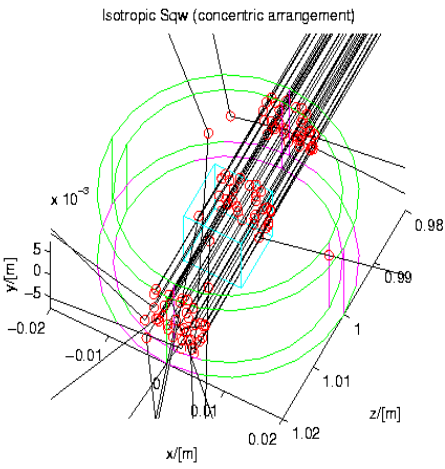

Virtual TOF exp. at IN6, ILL
 Liquid Ge sample
 Coherent / incoherent
 Multiple scattering
 And sample environment
 All contributions can be separated by VE !

E. Farhi, ILL



Data Analysis (2)

(using VE techniques)

- VE data has been used to test data analysis programs
- ... and to check resolution effects

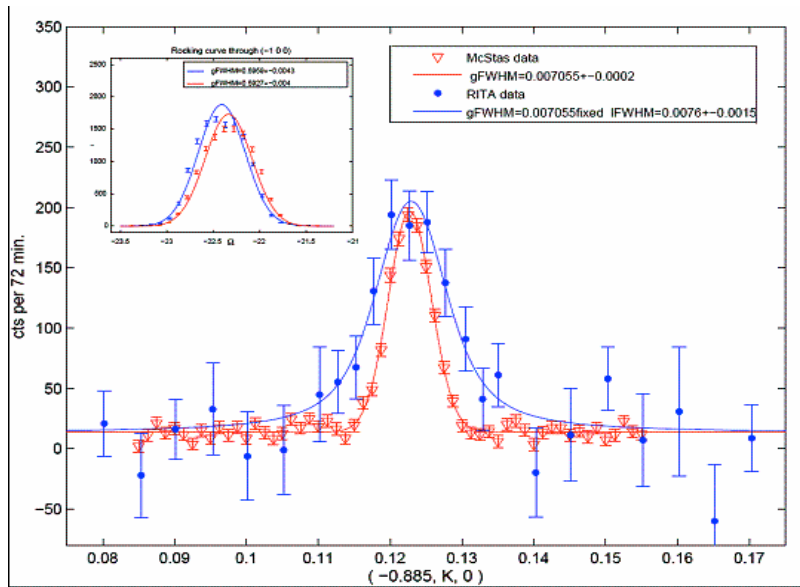

L. Udby, Risø-DTU

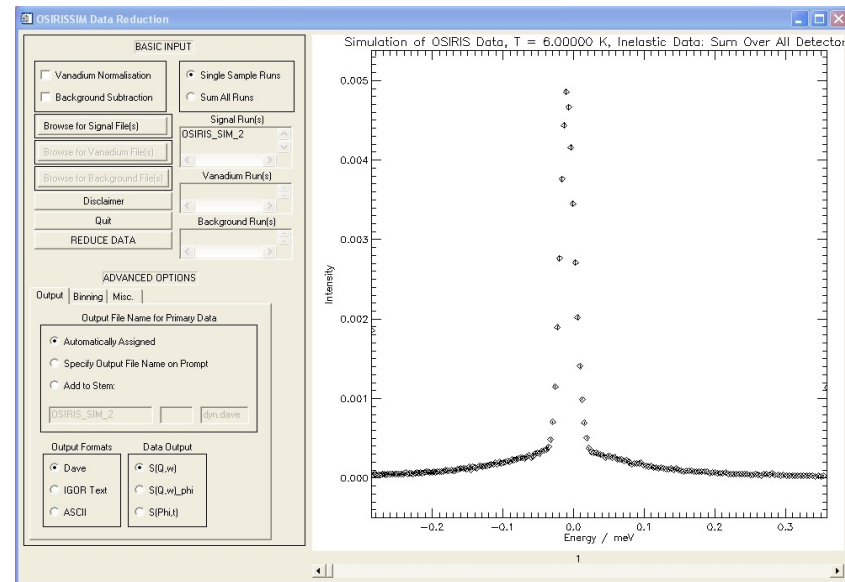

P. Tregenna-Piggott, PSI

Teaching / training purposes

- Workshops
- Teaching
 - University of Copenhagen course on Neutron Scattering 2005-, DTU 2011-

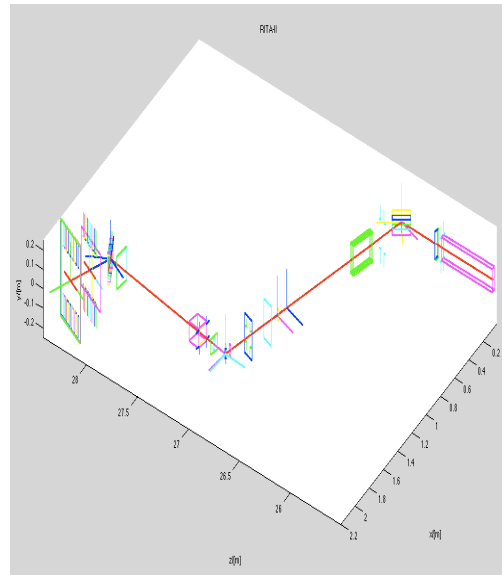
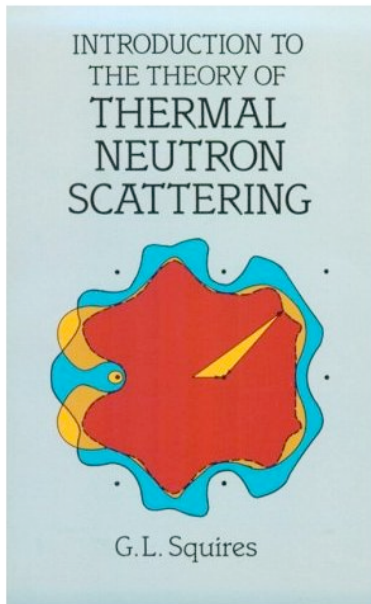

Reliability - cross comparisons

- Much effort has gone into this
- Here: simulations vs. exp. at powder diffract. DMC, PSI
- The bottom line is
- McStas agree very well with other packages (NISP, Vitess, IDEAS, RESTRAX, ...)
- Experimental line shapes are within 5%
- Absolute intensities are within 10%
- Common understanding: McStas and similar codes are reliable

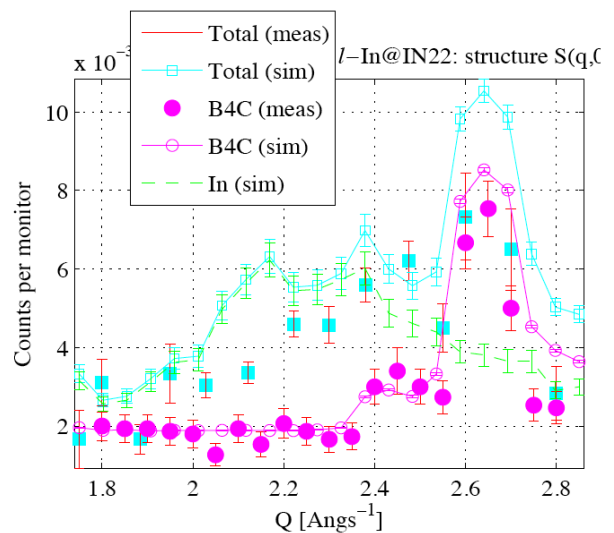

E. Farhi, P. Willendrup et al., in preparation

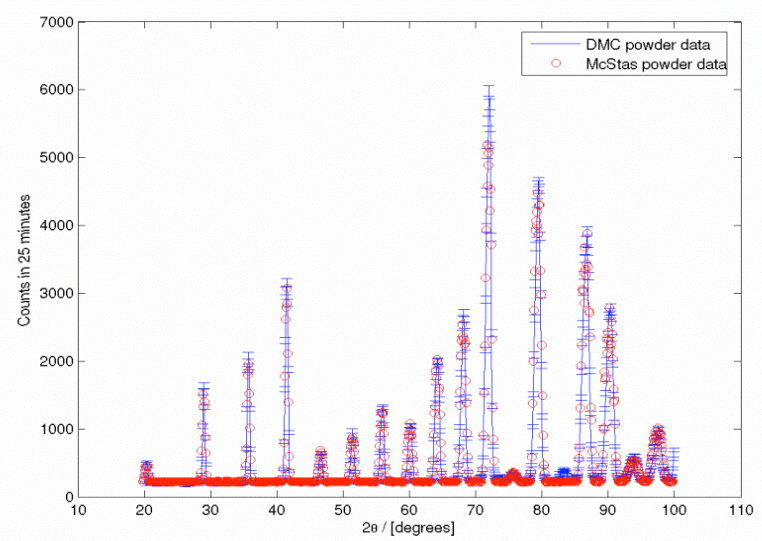

P. Willendrup et al., Physica B, 386, (2006), 1032.



McStas: key concepts

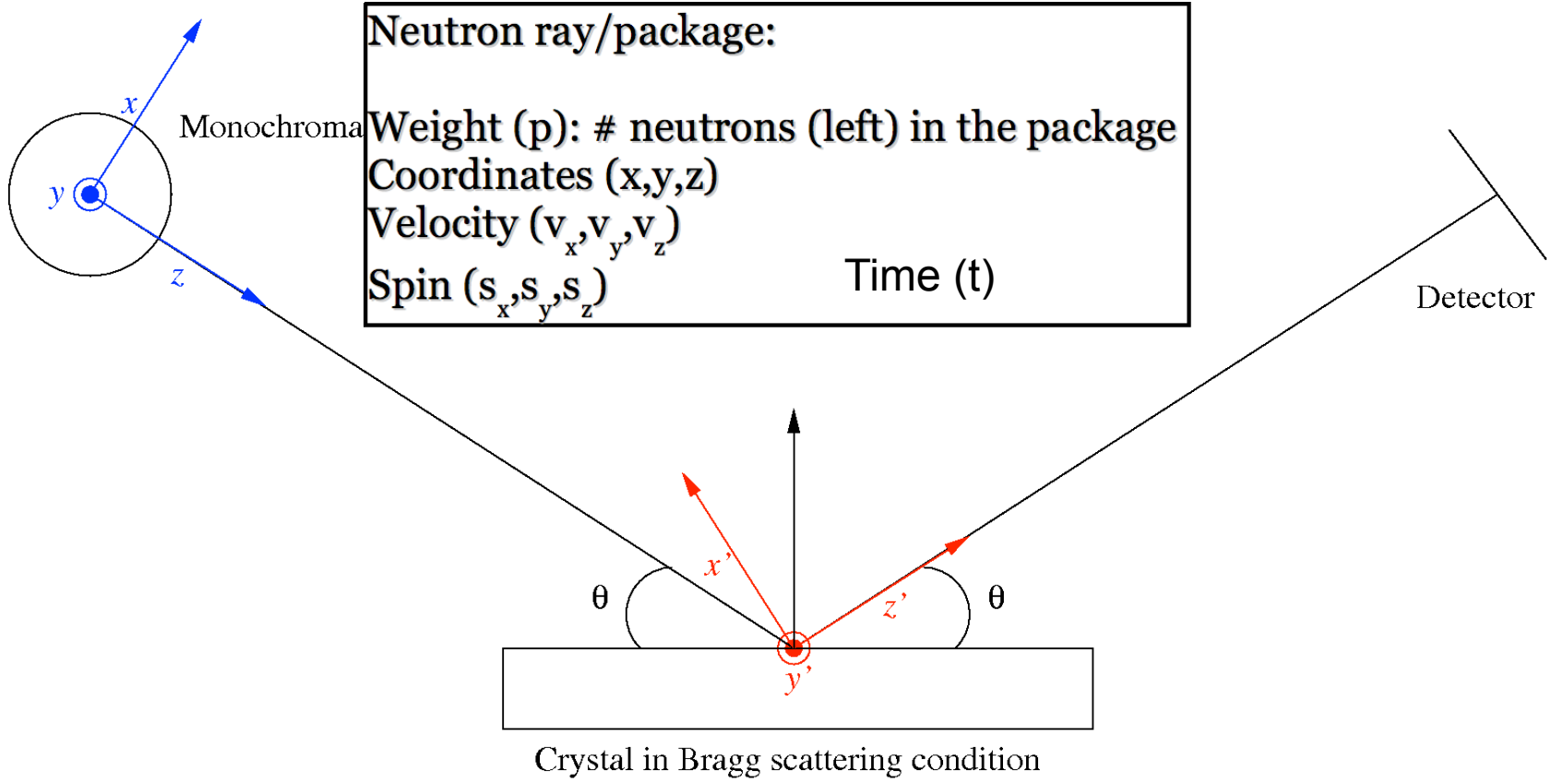

McStas: key concepts

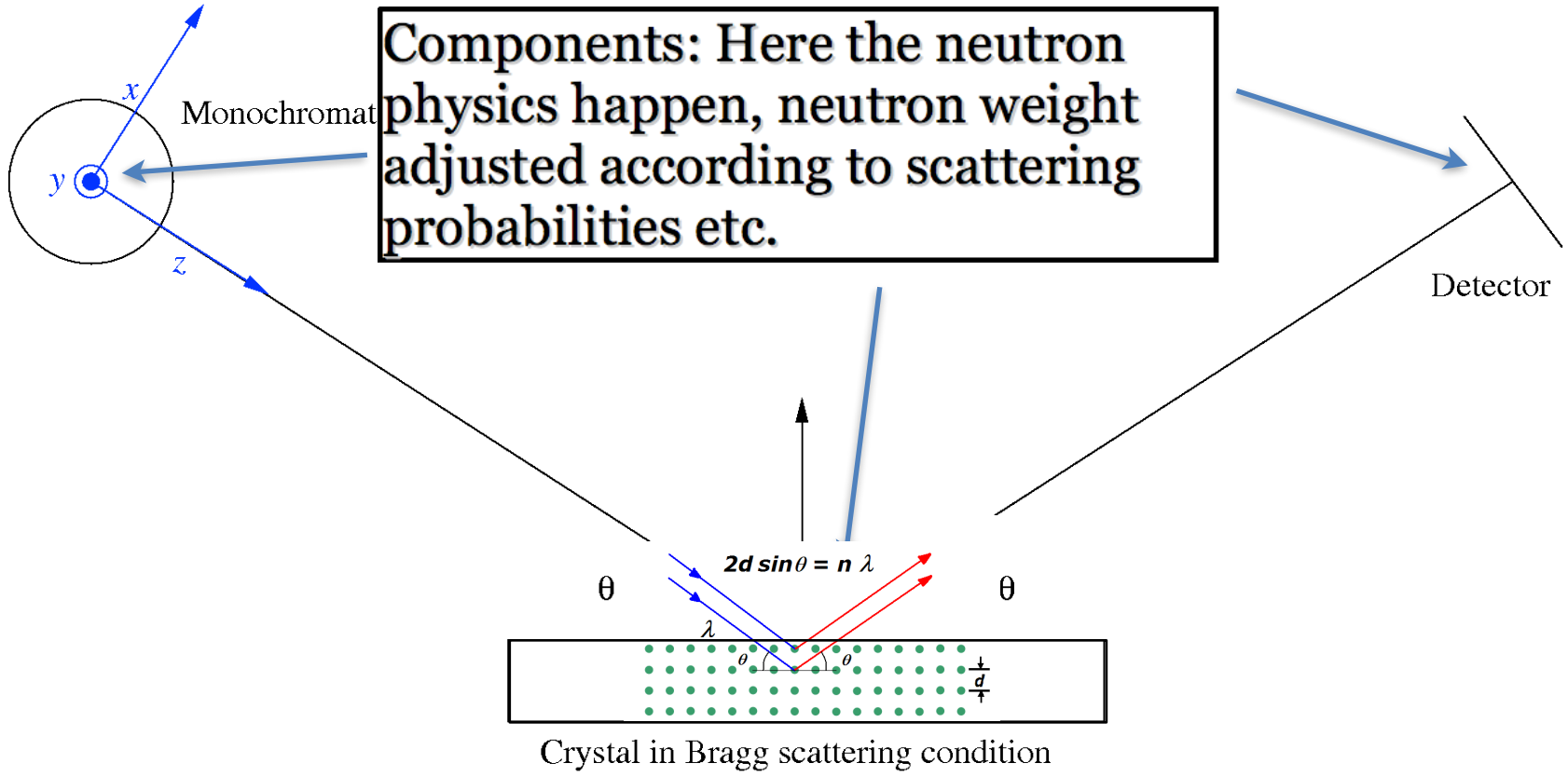

McStas: key concepts

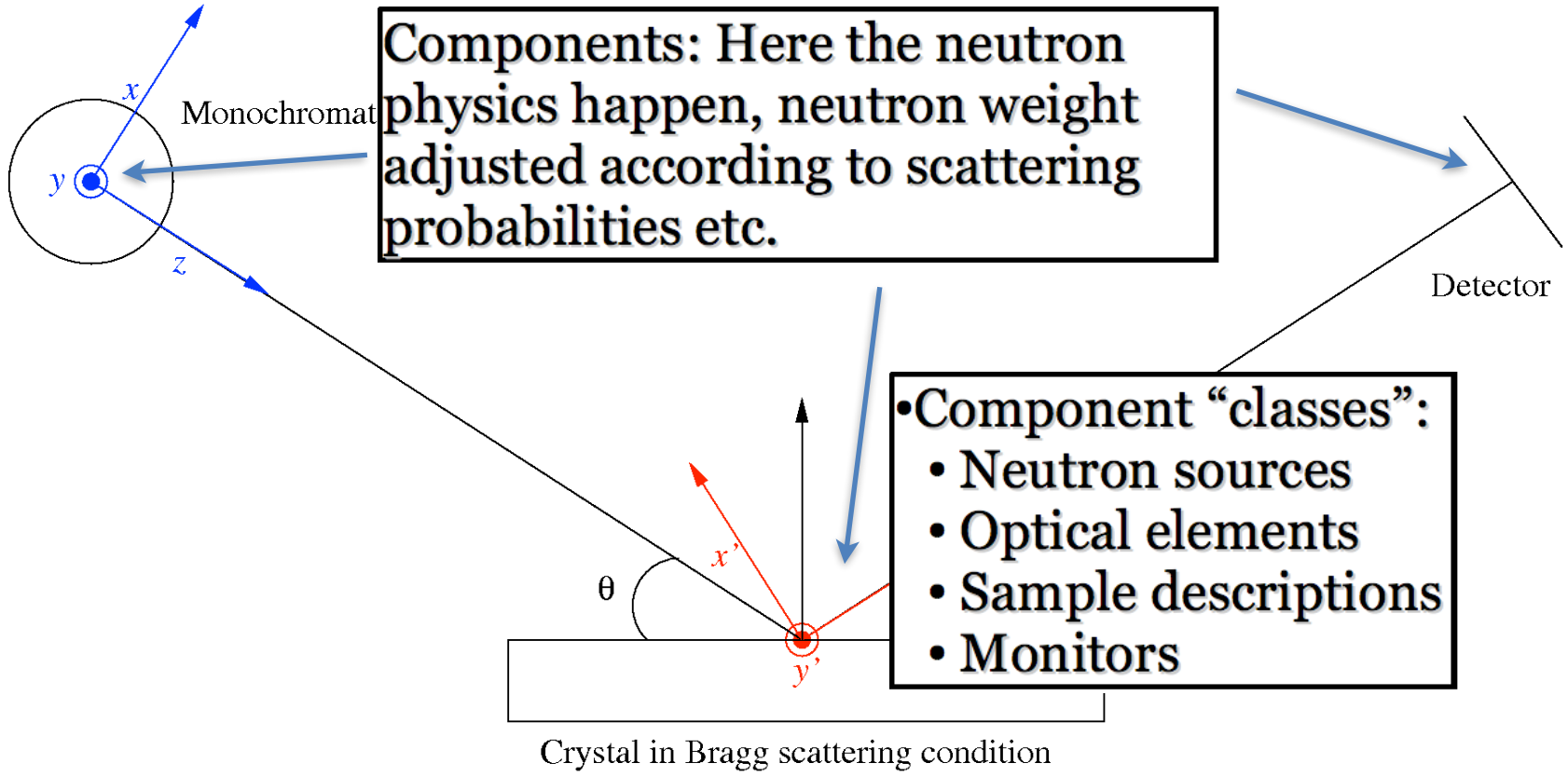

McStas: key concepts

Local, internal coordinate system!

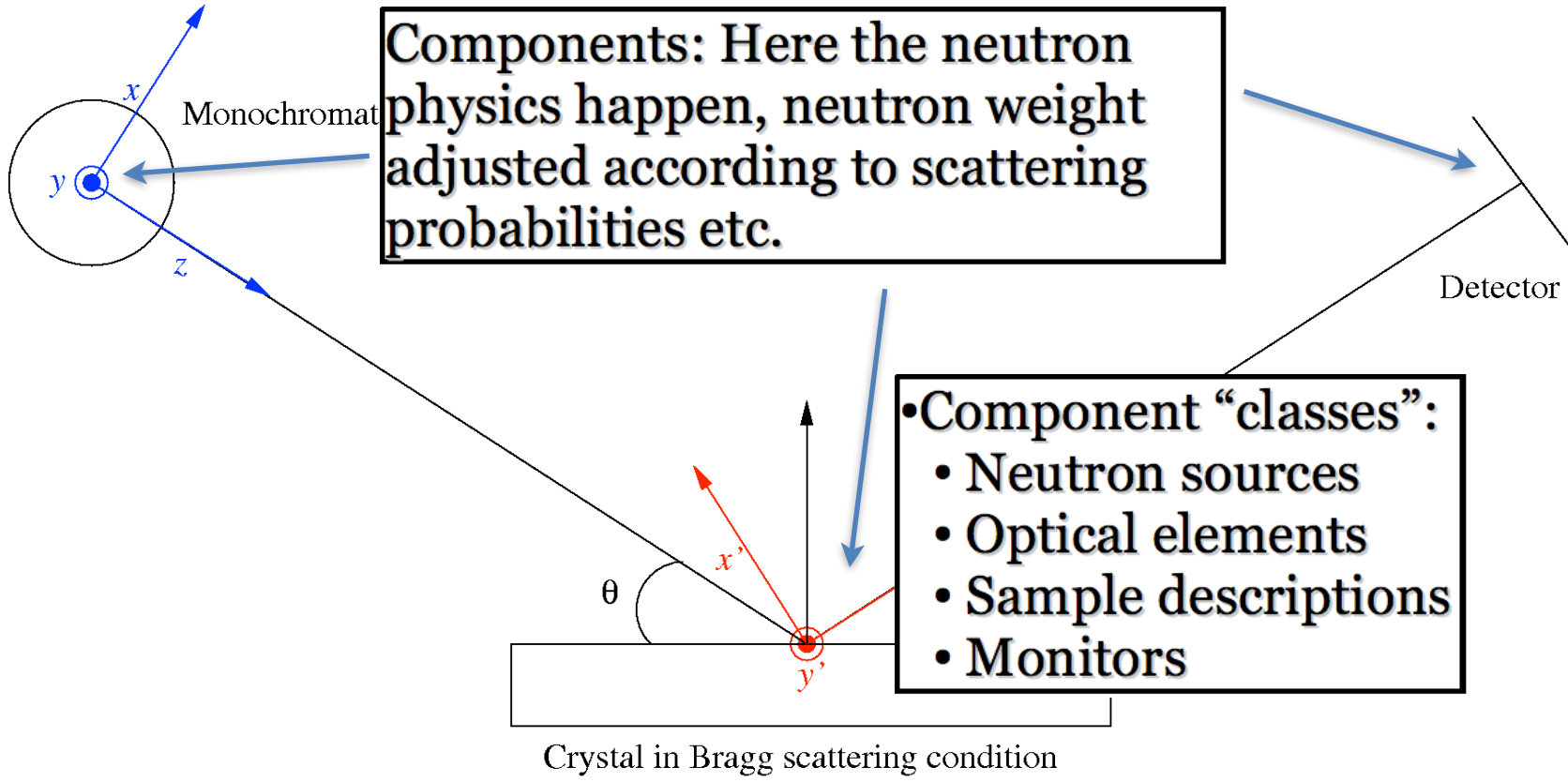

McStas: key concepts

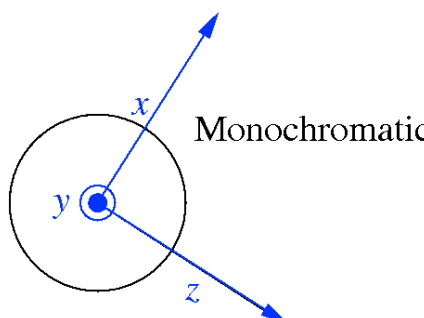

Instrument: positioning + transformation between sequential component coordinate systems, e.g. neutron source, crystal, detector.

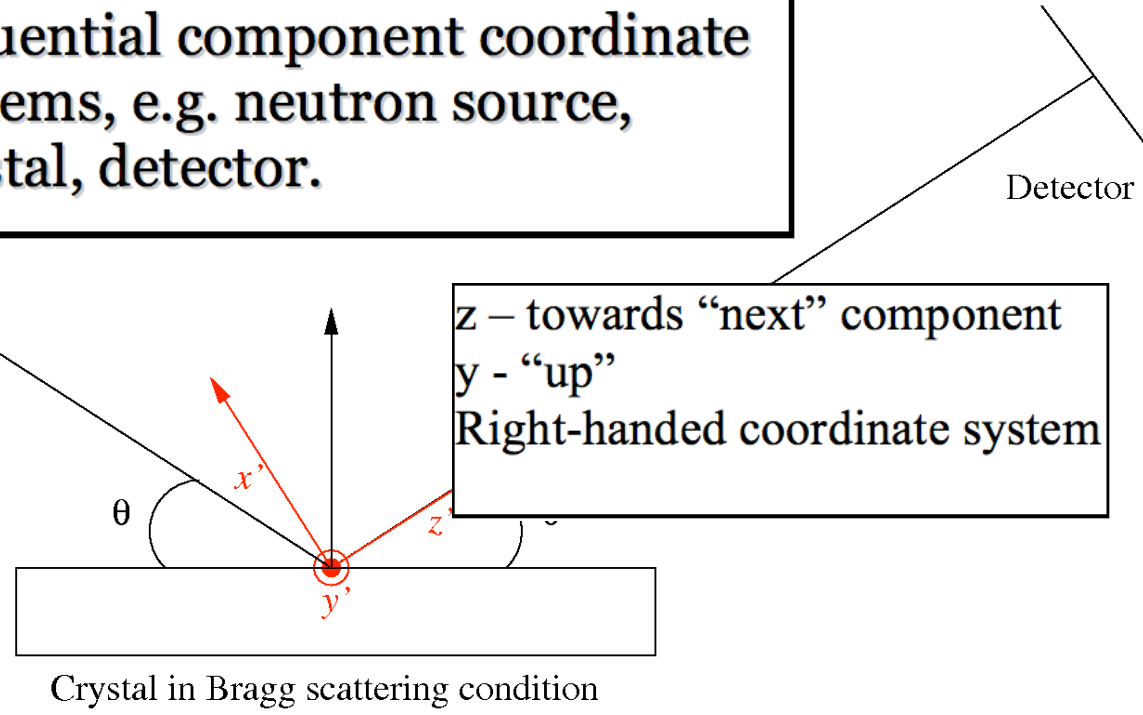

In the big picture...



1. Particles emitted with random starting conditions via MC

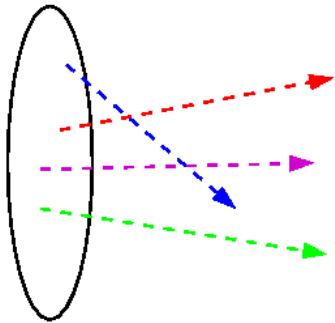

2. Particles are "ray-traced" through space

3. Will eventually meet other objects e.g. a studied experimental sample and get scattered via MC again

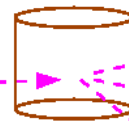

4. At various points in the instrument the particle states are measured in so-called monitors or detectors

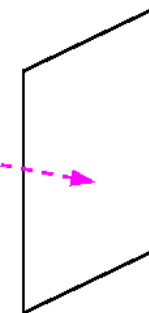

McStas overview

Portable code (Unix/Linux/Mac/Windows)



Ran on everything from iPhone to 1000+ node cluster!

'Component' files (~100) inserted from library

- Sources
- Optics
- Samples
- Monitors
- If needed, write your own comps

DSL + ISO-C code gen.

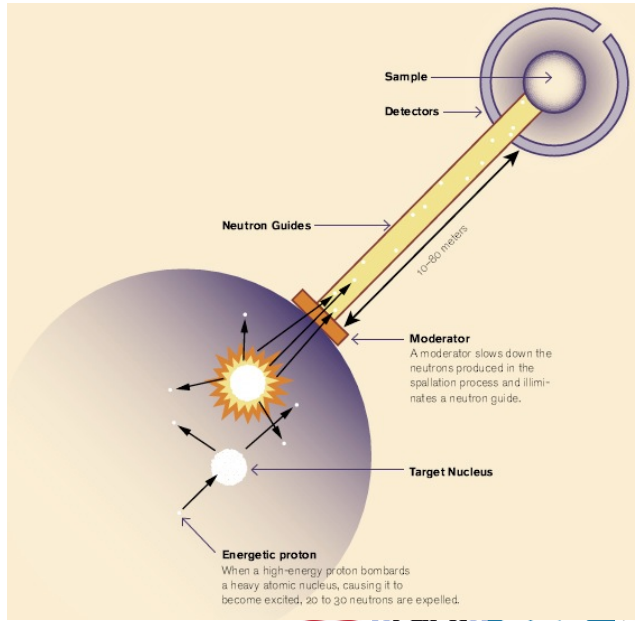

Under-the-hood / inner workings

Domain-specific-language (DSL) based on compiler technology (LeX+Yacc)

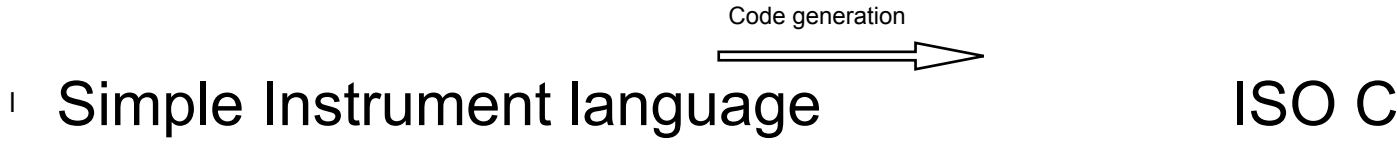

Component codes realizing beamline parts (including user contribs)

- Library of common functions for e.g.
 - I/O
 - Random numbers
 - Physical constants
 - Propagation
 - Precession in fields
 - ...

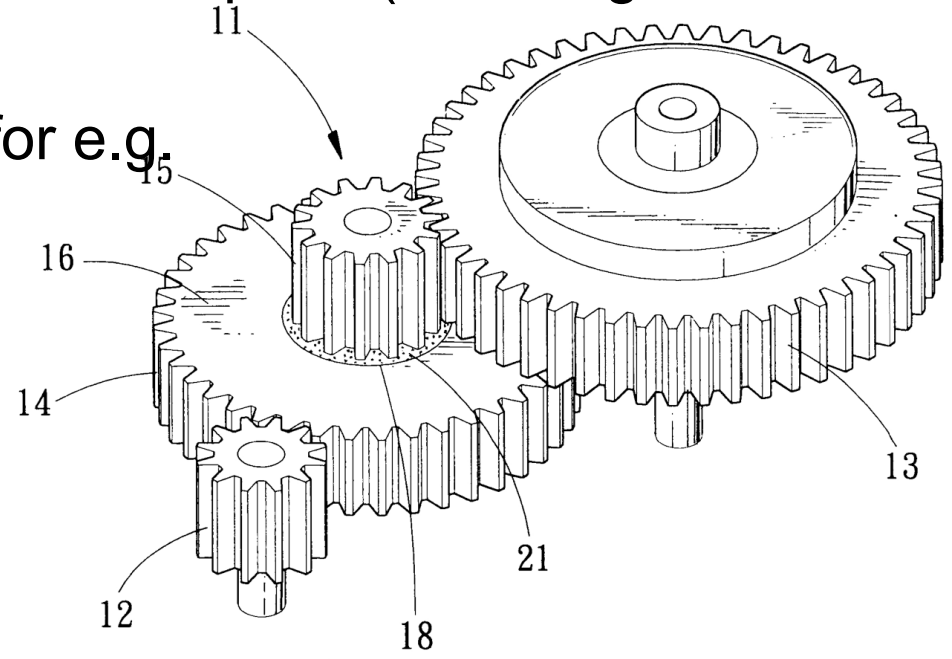

Implementation



- Three levels of source code:
 - Instrument file (All users)
 - Component files (Some users)
 - ANSI c code (no users)



Instrument file

```
DEFINE INSTRUMENT My_Instrument(DIST=10)

/* Here comes the TRACE section, where the actual      */
/* instrument is defined as a sequence of components.  */
TRACE

/* The Arm() class component defines reference points and orientations */
/* in 3D space.                                         */
COMPONENT Origin = Arm()
    AT (0, 0, 0) ABSOLUTE

COMPONENT Source = Source simple(
    radius = 0.1, dist = 10, xw = 0.1, yh = 0.1, E0 = 5, dE = 1)
    AT (0, 0, 0) RELATIVE Origin

COMPONENT Emon = E_monitor(
    filename = "Emon.dat", xmin = -0.1, xmax = 0.1, ymin = -0.1,
    ymax = 0.1, Emin = 0, Emax = 10)
    AT (0, 0, DIST) RELATIVE Origin

COMPONENT PSD = PSD_monitor(
    nx = 128, ny = 128, filename = "PSD.dat", xmin = -0.1,
    xmax = 0.1, ymin = -0.1, ymax = 0.1)
    AT (0, 0, 1e-10) RELATIVE Emon

/* The END token marks the instrument definition end */
END
```

Written by you!

Component file

```
*****
*
* Mcstas, neutron ray-tracing package
* Copyright 1997-2002, All rights reserved
* Risoe National Laboratory, Roskilde, Denmark
* Institut Laue Langevin, Grenoble, France
*
* Component: Source_flat
*
* %I
* Written by: Kim Lefmann
* Date: October 30, 1997
* Modified by: KL, October 4, 2001
* Modified by: Emmanuel Farhi, October 30, 2001. Serious bug corrected.
* Version: $Revision: 1.22 $
* Origin: Risoe
* Release: McStas 1.6
*
* A circular neutron source with flat energy spectrum and arbitrary flux
*
* %D
* The routine is a circular neutron source, which aims at a square target
* centered at the beam (in order to improve MC-acceptance rate). The angular
* divergence is then given by the dimensions of the target.
* The neutron energy is uniformly distributed between E0-dE and E0+dE.
*
* Example: Source_flat(radius=0.1, dist=2, xw=.1, yh=.1, E0=14, dE=2)
*
* %P
* radius: (m)   Radius of circle in (x,y,0) plane where neutrons
*               are generated.
* dist: (m)    Distance to target along z axis.
* xw: (m)     Width(x) of target
* yh: (m)     Height(y) of target
* E0: (meV)   Mean energy of neutrons.
* dE: (meV)   Energy spread of neutrons.
* Lambda0 (AA) Mean wavelength of neutrons.
* dLambda (AA) Wavelength spread of neutrons.
* flux (1/(s*cm**2*st)) Energy integrated flux
*
* %E
*****/

DEFINE COMPONENT Source_simple
DEFINITION PARAMETERS ()
SETTING PARAMETERS (radius, dist, xw, yh, E0=0, dE=0, Lambda0=0, dLambda=0, flux=1)
OUTPUT PARAMETERS ()
STATE PARAMETERS (x, y, z, vx, vy, vz, t, s1, s2, p)
DECLARE
%{
double pmul, pdir;
%}
INITIALIZE
%{
pmul=flux*PI*1e4*radius*radius/mcget_ncount();
%}

TRACE
%{
double chi,E,Lambda,v,r, xf, yf, rf, dx, dy;

t=0;
z=0;

chi=2*PI*rand01(); /* Choose point on source */
r=sqrt(rand01()*radius); /* with uniform distribution. */
x=r*cos(chi);
y=r*sin(chi);
randvec_target_rect(&xf, &yf, &rf, &pdir,
0, 0, dist, xw, yh, ROT_A_CURRENT_COMP);

dx = xf-x;
dy = yf-y;
rf = sqrt(dx*dx+dy*dy+dist*dist);

p = pdir*pmul;

if(Lambda0==0) {
E=E0+dE*randpml(); /* Choose from uniform distribution */
v=sqrt(E)*SE2V;
} else {
Lambda=Lambda0+dLambda*randpml();
v = K2V*(2*PI/Lambda);
}

vz=v*dist/rf;
vy=v*dy/rf;
vx=v*dx/rf;
%}

MCDISPLAY
%{
magnify("xy");
circle("xy", 0, 0, 0, radius);
%}

END
```

Written by developers
and possibly you!

Generated c-code

```
/* Automatically generated file. Do not edit.
 * Format:      ANSI C source code
 * Creator:     McStas <http://neutron.risoe.dk>
 * Instrument:  My_Instrument.instr (My_Instrument)
 * Date:       Sat Apr  9 15:27:56 2005
 */

/* THOUSANDS of lines removed here.... */

/* TRACE Component Source. */
SIG MESSAGE("Source (Trace)");
mcDEBUG_COMP("Source")
mccoordschange(mccposrSource, mcrotrSource,
               &mcnlx, &mcnly, &mcnlz,
               &mcnlvx, &mcnlvy, &mcnlvz,
               &mcnlt, &mcnlxs, &mcnlly);
mcDEBUG_STATE(mcnlx, mcnly, mcnlz, mcnlvx, mcnlvy, mcnlvz, mcnlt, mcnlxs, mcnlly, mcnlp);
#define x mcnlx
#define y mcnly
#define z mcnlz
#define vx mcnlvx
#define vy mcnlvy
#define vz mcnlvz
#define t mcnlt
#define s1 mcnlxs
#define s2 mcnlly
#define p mcnlp
STORE_NEUTRON(2, mcnlx, mcnly, mcnlz, mcnlvx, mcnlvy, mcnlvz, mcnlt, mcnlxs, mcnlly, mcnlsz, mcnlp);
mcScattered=0;
mcNCounter[2]++;
#define mccoordinate Source
#define mccoordinateindex 2
{ /* Declarations of SETTING parameters. */
MCNUM radius = mccSource_radius;
MCNUM dist = mccSource_dist;
MCNUM xw = mccSource_xw;
MCNUM yh = mccSource_yh;
MCNUM E0 = mccSource_E0;
MCNUM dE = mccSource_dE;
MCNUM Lambda0 = mccSource_Lambda0;
MCNUM dLambda = mccSource_dLambda;
MCNUM flux = mccSource_flux;
#line 58 "Source_simple.comp"
{
double chi, E, Lambda, v, r, xf, yf, rf, dx, dy;

t=0;
z=0;

chi=2*PI*rand01();
r=sqrt(rand01())*radius; /* Choose point on source */
x=r*cos(chi);           /* with uniform distribution. */
y=r*sin(chi);

randvec_target_rect(&xf, &yf, &rf, &dir,
                   0, 0, dist, xw, yh, ROT_A_CURRENT_COMP);
```

Written by mcstas!

McStas is a (pre)compiler!

Input is .comp and .instr files +
runtime functions for e.g. random
numbers

Output is a single c-file, which can
be compiled using e.g. gcc.

Can take input arguments if
needed.

Writing new comps or understanding existing is not that complex...

- Check our long list of components and look inside... Most of them are quite simple and short... Statistics:

Number of codelines per component – 136 comps (update: 175)

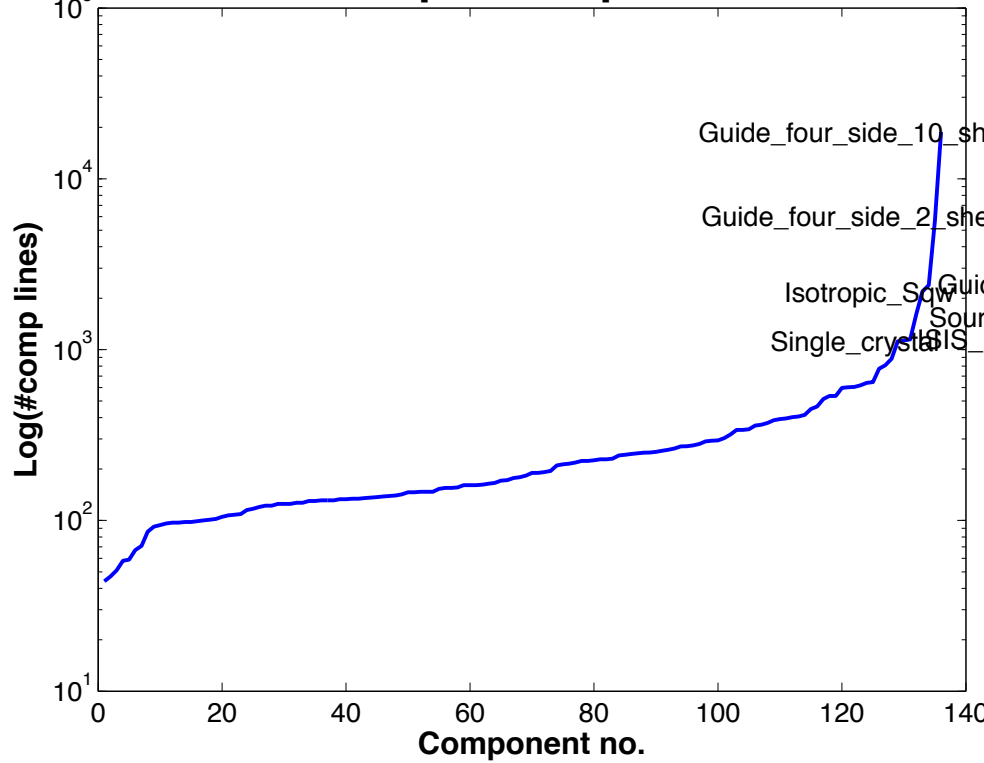

Including user contribs

I Well-developed community support

- 30-40% of existing and new additions are from users
- No direct refereeing of the code, but these requirements:
 - At least one test-instrument
 - Meaningful documentation headers (in-code docs)
- Contributions go in dedicated contrib/ section of library

I Natural life-cycle of contrib's

- Bug-fixes are applied both by contributor and developers
- If contributor becomes unavailable either:
 - Many users of comp: Promote to official components, e.g. in optics/
 - Few/no users of comp: Move to obsolete/ until next major release

Example suite: ~140 instruments

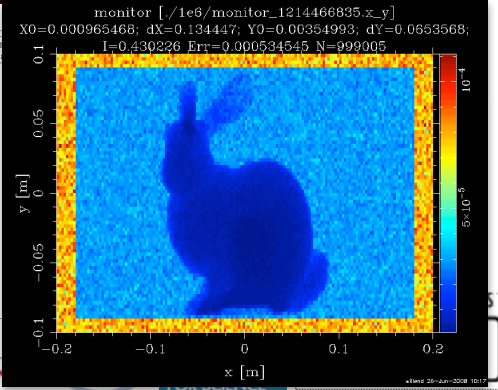
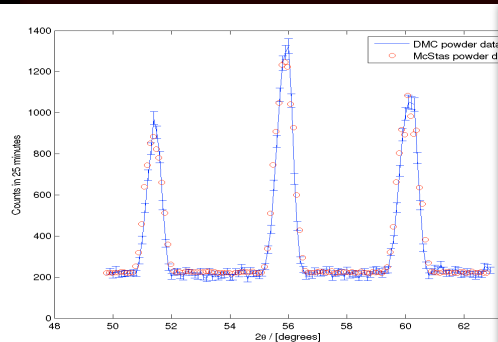
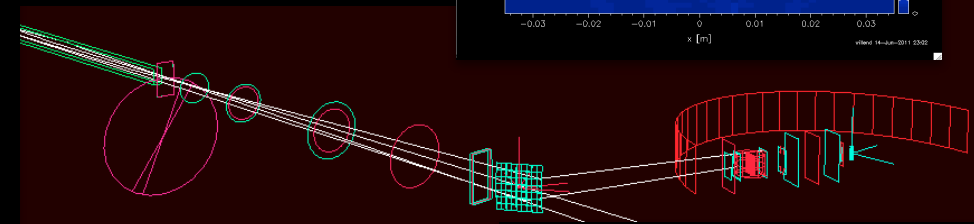
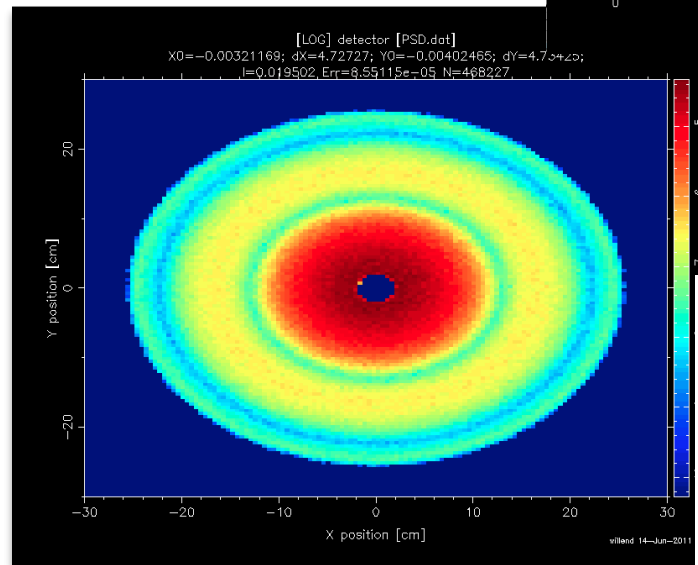
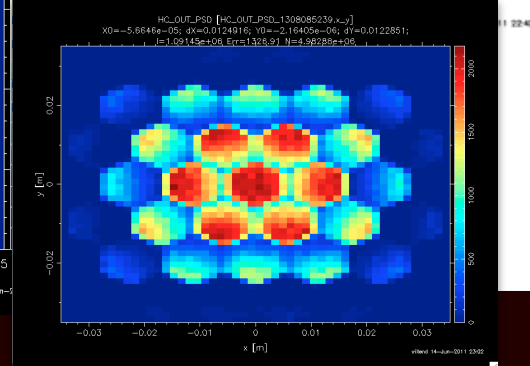
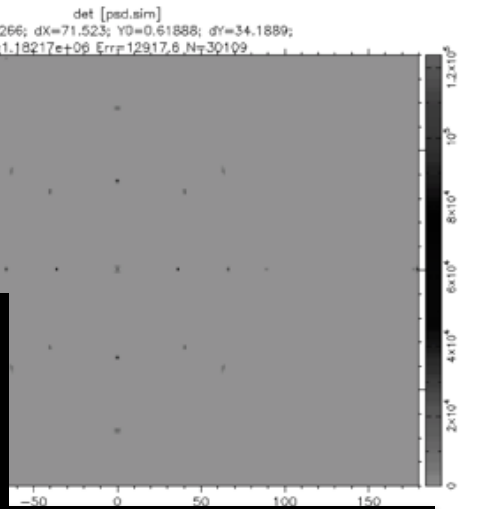
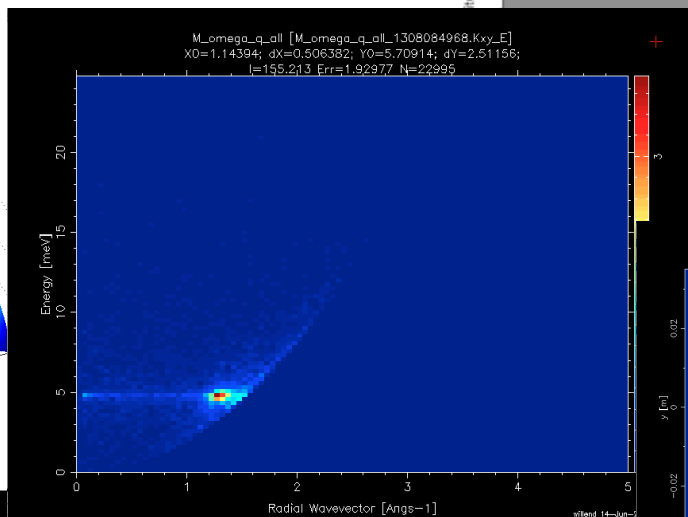
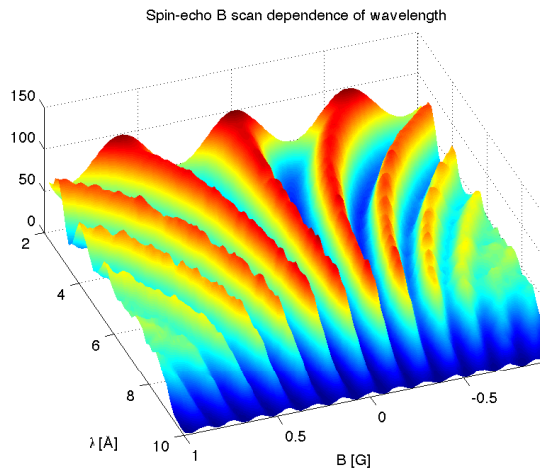

Forming groups

† Suggestion for Monday-Wednesday exercises (1-11):

- † Often sitting with a colleague is helpful
- † Form teams of two people for the exercises
- † Try to gather complementary knowledge by teaming up with someone from a different work area



Enough Talk! Let's see McStas run?

The screenshot displays the McStas software interface with several windows open:

- McStas: h8_test.instr**: The main simulation window showing the instrument file, simulation results (mcstas.sim), and status (Done). It lists detector configurations and simulation parameters.
- Run simulation h8_test.instr**: A dialog box for running the simulation. It shows the instrument source (h8_test.instr), instrument parameters (Lambda (D): 2.36), output directory, neutron count (1000000), and simulation options like gravity and random seed.
- PGPLOT Window 1**: A window displaying a grid of 12 heatmaps, likely representing detector response or simulation results.
- TOF diagram: Xtalog.out**: A plot showing the Time-of-Flight (TOF) distribution. The x-axis is TOF [ms] (0 to 100) and the y-axis is Z Axis [m] (0 to 60). It shows multiple peaks corresponding to different detector components.
- 3D Model**: A 3D visualization of the instrument geometry, showing the source, guides, and detectors in a coordinate system with z [m] on the x-axis.

